

MİMARİ KATALOG
ARCHITECTURAL CATALOGUE

Alüminyum Kapı Pencere ve Giydirme Cephe Sistemleri
Aluminium Window Doors and Facade Systems

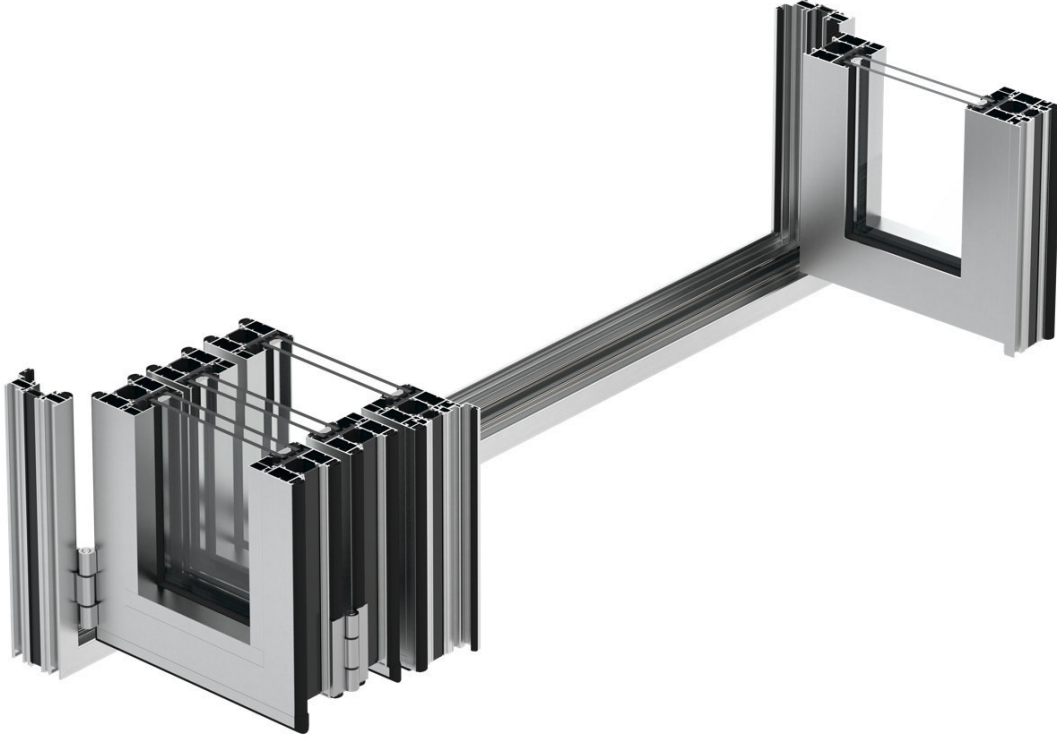

REFD77

TEKNİK ÖZELLİKLER TECHNICAL PROPERTIES

REFD77

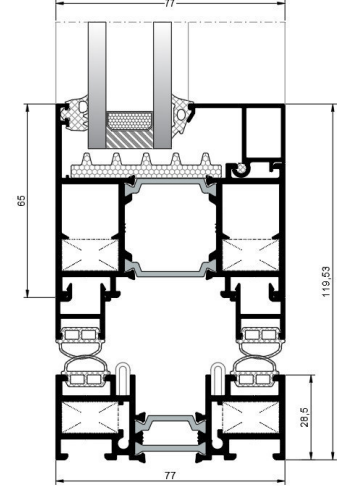

TEKNİK ÖZELLİKLERİ / TECHNICAL PROPERTIES

KASA DERİNLİĞİ / FRAME DEPTH	77mm
KANAT DERİNLİĞİ / VENT DEPTH	65mm
PROFİL ET KALINLIĞI / WALL THICKNESS	1,8mm
MAX. CAM KALINLIĞI / MAX. GLASS THICKNESS	24 / 28 / 32 / 36 / 50mm
ISI BARIYERLERİ / THERMAL INSULATION BAR	24 / 31mm

KULLANIM SEÇENEKLERİ / APPLICATION ALTERNATIVES

KATLANIR / FOLDING	KAPI DOOR	PENCERE WINDOW
	*	*

HAVA GEÇİRGENLİĞİ - EN 12207 (AIR PERMEABILITY)	1 (150 Pa)	2 (300 Pa)	3 (450 Pa)	4 (600 Pa)					
SU SIZDIRMAZLIĞI - EN 12208 (WATERTIGHTNESS)	2A (50 Pa)	3A (100 Pa)	4A (150 Pa)	5A (200 Pa)	6A (250 Pa)	7A (300 Pa)	8A (450 Pa)	9A (600 Pa)	E750 (600+ Pa)
RÜZGAR YÜKÜNE DAYANIM - EN 12210 (RESISTANCE TO WIND LOAD)	1 (400 Pa)	2 (800 Pa)	3 (1200 Pa)	4 (1600 Pa)	5 (2000 Pa)	E... (2000+ Pa)			
SEHİM KRİTERİ - EN 12210 (DEFLECTION CRITERIA)	A (L/150)	B (L/200)	C (L/300)						
SİSTEM UF DEĞERİ - EN 10077-2 (THERMAL INSULATION VALUE)									2,16 - 2,90 W/M²K

1. ALÜMİNYUM ALAŞIM / ALUMINIUM ALLOY	EN AW 6060 T66
2. MEKANİK ÖZELLİKLER / MECHANICAL PROPERTIES	EN 755-2
KOPMA AKMA MUKAVEMETİ / YIELD-FLOW STRENGTH	215 N/mm ² -60 N/ mm
UZAMA A50 / ELONGATION A50	%6 (min.)
SERTLİK / HARDNESS	70 HRB
3.ÖLÇÜ TOLERANSLARI / DIMENSIONAL TOLLERANCES	EN 12020- 2
4. ISI BARIYERİ / THERMAL INSULATION BARS	PA 66 GF 25
5.YÜZEY İŞLEMLER / SURFACE TREATMENT	
5.1 ELOKSAL / ANODIC OXIDATION	EN 17611 / QUALANOD
KALINLIK / THICKNESS OF ANODIC OXIDATION	15-20 MICRON EN ISO 2360
5.2 TOZ BOYA / POWDER COATING	QUALICOAT-SEASIDE
KALINLIK / THICKNESS OF POWDER COATING	MIN 60 MICRON
6. TÜM FİTİLLER / ALL GASKETS	EPDM / POLİPROPİLEN
<p>*SİSTEM İMALATINDA SADECE BU SİSTEM İÇİN TASARLANAN VE ÜRETİLEN ; SİSTEM KATALOĞUNDA İLAN EDİLEN FİTİLLER KULLANILMALIDIR. FARKLI FİTİL KULLANIMLARI İŞLEVSEL VE TASARIMSAL SORUNLARA SEBEP OLABİLİR.</p> <p>THE GASKETS USED DURING ASSEMBLING AND INSTALLING THE COMPONENTS SHOULD BE ONLY THE ONES CREATED FOR THIS SYSTEM AND DISPLYED IN THIS PRODUCT CATALOGUE. THE USE OF OTHER GASKETS OR/AND BRUSHES IT MAY CAUSE FUNCTIONAL AND DESIGN PROBLEMS.</p>	
7. AKSESUARLAR / ACCESSORIES	
<p>*İMALATTA KULLANILAN TÜM AKSESUARLAR SİSTEMİN YÜKSEK PERFORMANS İLE ÇALIŞABİLMESİ İÇİN SADECE BU SİSTEME ÖZEL OLARAK TASARLANMIŞTIR. KATALOGDA İLAN EDİLENDEN FARKLI AKSESUAR KULLANIMLARI SİSTEMİN DOĞRU ÇALIŞMASINI ENGELLEYEBİLİR.</p> <p>ALL THE ACCESSORIES USED FOR THE MANUFACTURING, MOUNTING, FUNCTIONING AND INSTALLATION OF THIS SYSTEM ARE SPECIFICALLY STUDIED FOR THIS SYSTEM IN ORDER TO INSURE PERFORMANCES AND A CORRECT FUNCTIONNING OF THE MODELS. THE USE OF OTHERS ACCESSORIES DIFFERENTS FROM THE ONES DISPLAYED IN THIS CATALOGUE IT MAY EFFECT OR/AND MAKE DANGEROUS THE FUNCTIONNING OF THE COMPONENT.</p>	

TEKNİK ÖZELLİKLER TECHNICAL PROPERTIES

REFD77

ISI YALITIM DEĞERLERİ (UF)
THERMAL INSULATION VALUES(UF)

CAM KALINLIKLARI 24 / 28 / 32 / 36 / 50 MM
GLASS THICKNESS 24 / 28 / 32 / 36 / 50 MM

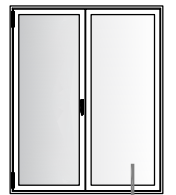
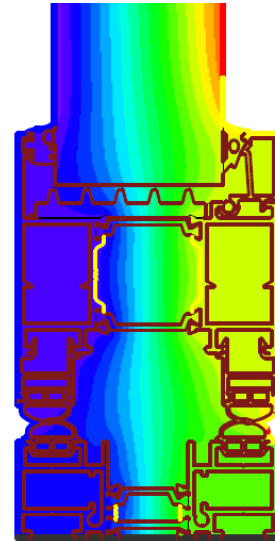
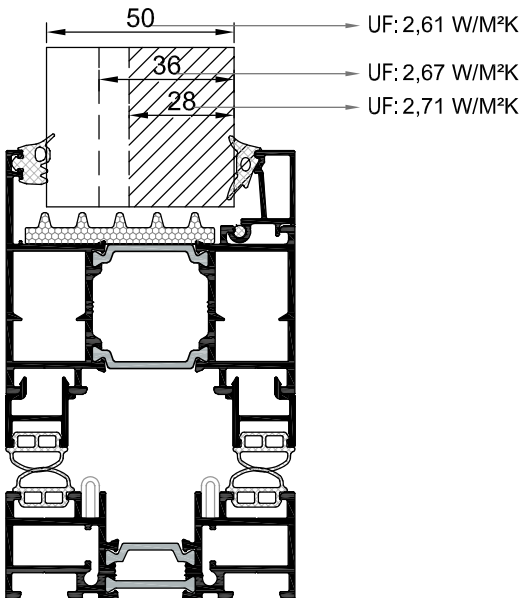
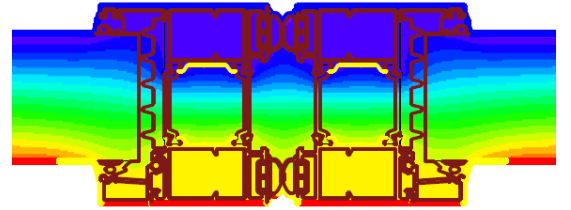
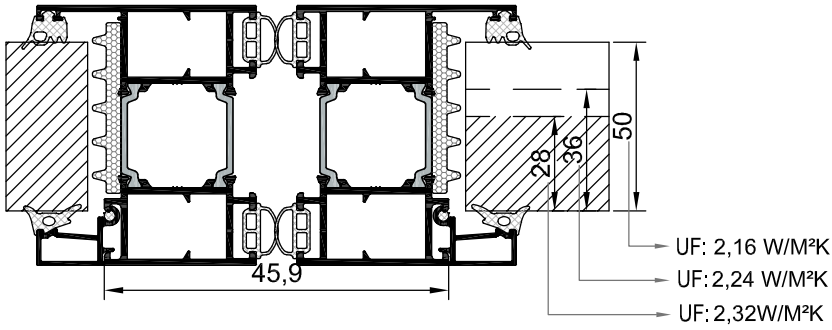
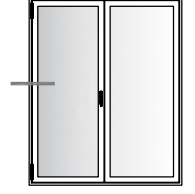
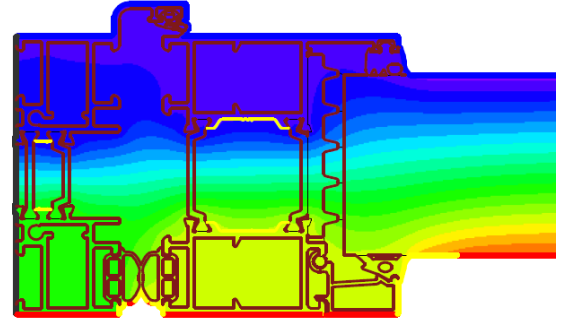
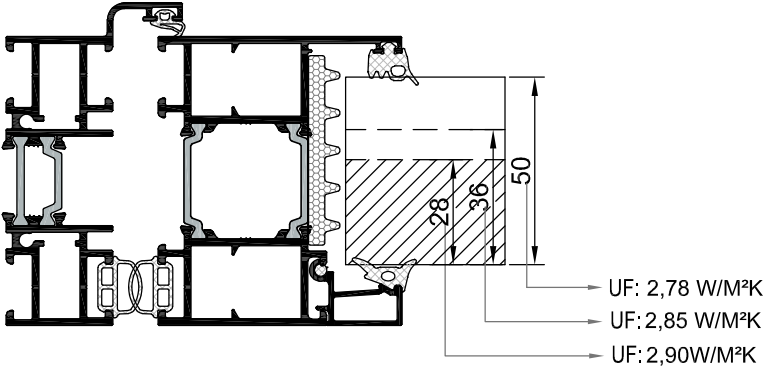

MİMARİ KATALOG
ARCHITECTURAL CATALOGUE







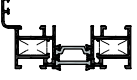
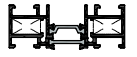
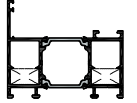

Alüminyum Kapı Pencere ve Giydirme Cephe Sistemleri
Aluminium Window Doors and Facade Systems

REFD77





PROFİLLER

PROFILES

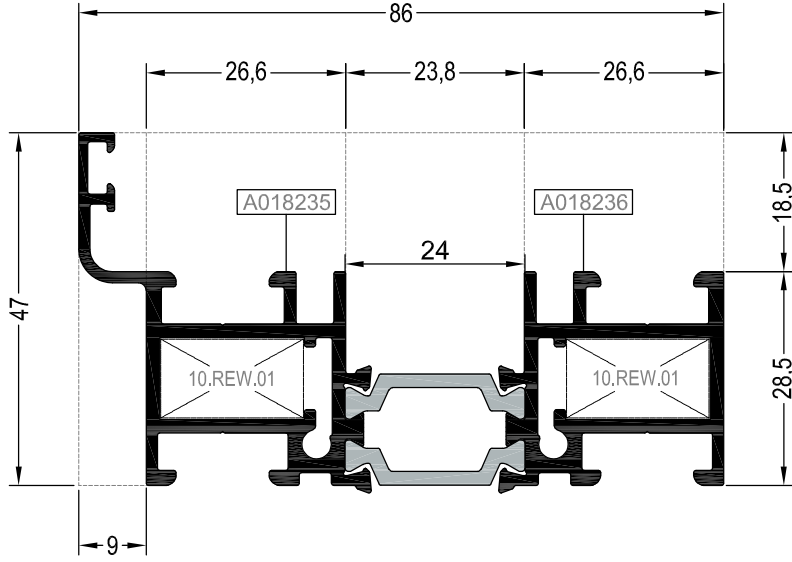



PROFİL FİHRİSTİ / PROFILE FİHRİST

	PROFİL RESMİ DRAWING	PROFİL TANIMI PROFILE DESCRIPTION	RESCARA KODU RESCARA CODE	KALIP KODU MOLD CODE	AĞIRLIK (kg/m) WEIGHT (kg/m)	SAYFA PAGE
1		KASA PROFİLİ FRAME PROFILE	AREFD1001	A018235 A018236	1,658	C-1
2		KASA PROFİLİ FRAME PROFILE	AREFD1002	A018236 A018236	1,526	C-1
3		KANAT PROFİLİ VENT PROFILE	AREFD2001	A018237 A018238	1,781	C-2
4		ADAPTÖR PROFİLİ ADAPTER PROFILE	AREFD4005	A019160 A019161	1,134	C-2
5		ADAPTÖR PROFİLİ ADAPTER PROFILE	REFD 4001	A018246	0,240	C-3
6		ADAPTÖR PROFİLİ ADAPTER PROFILE	REFD 4003	A018240	0,227	C-3
7		CAM ÇİTA PROFİLİ GLAZING PROFILE	REFD 5001	A018241	0,336	C-4
8		CAM ÇİTA PROFİLİ GLAZING PROFILE	REFD 5002	A018242	0,323	C-4
9		CAM ÇİTA PROFİLİ GLAZING PROFILE	REFD 5003	A018243	0,31	C-4
10		CAM ÇİTA PROFİLİ GLAZING PROFILE	REFD 5004	A018244	0,297	C-4
11		CAM ÇİTA PROFİLİ GLAZING PROFILE	REFD 5005	A018245	0,241	C-4
12						
13						
14						
15						

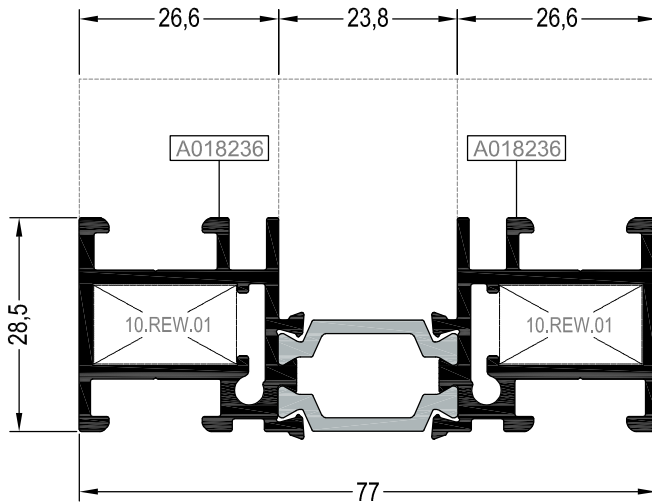





AREFD1001		
	AĞIRLIK WEIGHT (kg/m)	1,658
	MALZEME MATERIAL	Alüminyum
	UZUNLUK LENGTH (m)	6
	Jx (cm ⁴)	4,647
	Jy (cm ⁴)	41,652

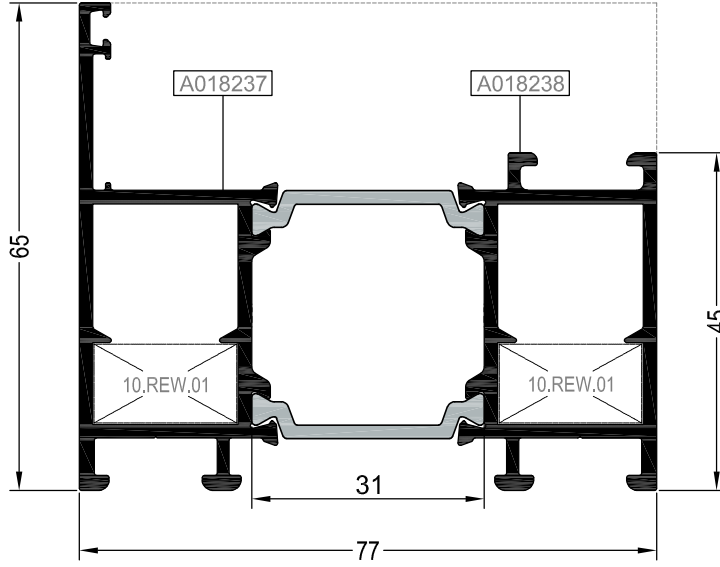





AREFD1002		
	AĞIRLIK WEIGHT (kg/m)	1,526
	MALZEME MATERIAL	Alüminyum
	UZUNLUK LENGTH (m)	6
	Jx (cm ⁴)	3,647
	Jy (cm ⁴)	32,626

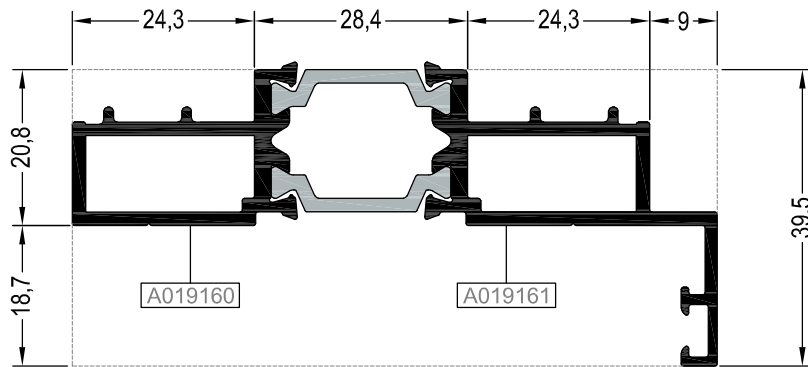





AREFD2001		
 AĞIRLIK WEIGHT (kg/m)		1,781
 MALZEME MATERIAL		Alüminyum
 UZUNLUK LENGTH (m)		6
	Jx (cm ⁴)	11,395
	Jy (cm ⁴)	47,748

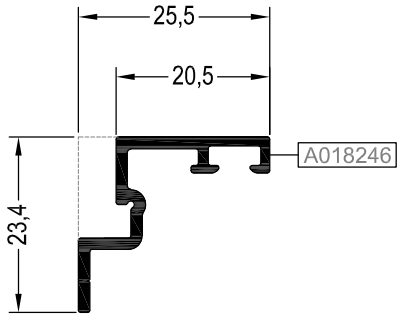





AREFD4005		
 AĞIRLIK WEIGHT (kg/m)		1,290
 MALZEME MATERIAL		Alüminyum
 UZUNLUK LENGTH (m)		6
	Jx (cm ⁴)	2,09
	Jy (cm ⁴)	57,85

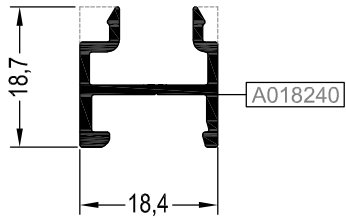

REFD 4001		
 AĞIRLIK WEIGHT (kg/m)		0,24
 MALZEME MATERIAL		Alüminyum
 UZUNLUK LENGTH (m)		6
 Jx (cm ⁴)		-
 Jy (cm ⁴)		-



REFD 4003		
 AĞIRLIK WEIGHT (kg/m)		0,227
 MALZEME MATERIAL		Alüminyum
 UZUNLUK LENGTH (m)		6
 Jx (cm ⁴)		-
 Jy (cm ⁴)		-

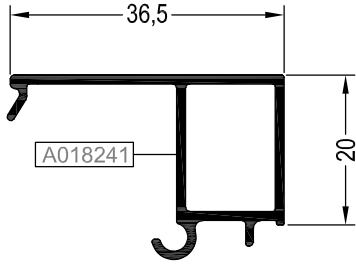

REFD 5001		
	AĞIRLIK WEIGHT (kg/m)	0,336
	MALZEME MATERIAL	Alüminyum
	UZUNLUK LENGTH (m)	6
	Jx (cm ⁴)	-
	Jy (cm ⁴)	-

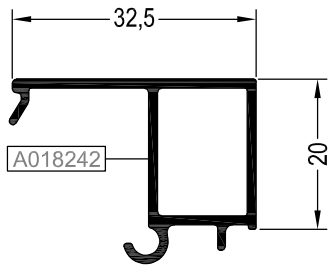
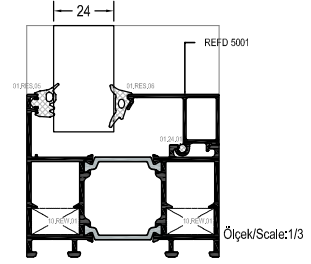

REFD 5002		
	AĞIRLIK WEIGHT (kg/m)	0,323
	MALZEME MATERIAL	Alüminyum
	UZUNLUK LENGTH (m)	6
	Jx (cm ⁴)	-
	Jy (cm ⁴)	-

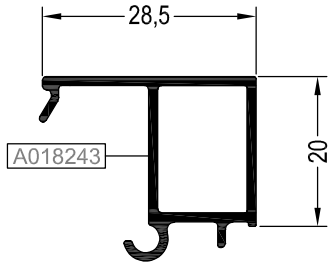
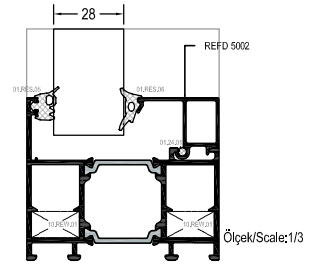

REFD 5003		
	AĞIRLIK WEIGHT (kg/m)	0,31
	MALZEME MATERIAL	Alüminyum
	UZUNLUK LENGTH (m)	6
	Jx (cm ⁴)	-
	Jy (cm ⁴)	-

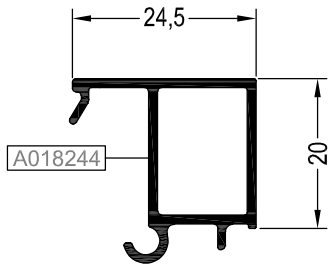
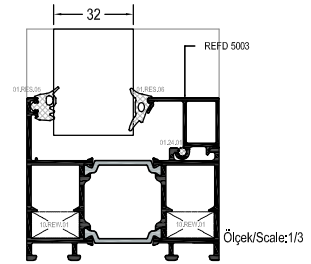

REFD 5004		
	AĞIRLIK WEIGHT (kg/m)	0,297
	MALZEME MATERIAL	Alüminyum
	UZUNLUK LENGTH (m)	6
	Jx (cm ⁴)	-
	Jy (cm ⁴)	-

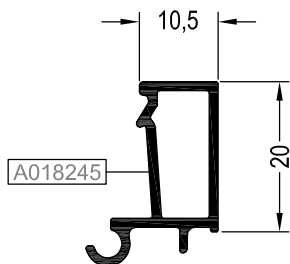
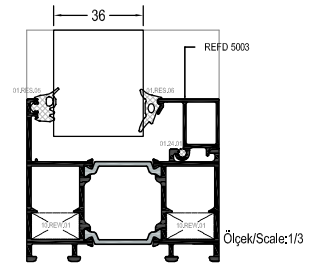

REFD 5005		
	AĞIRLIK WEIGHT (kg/m)	0,241
	MALZEME MATERIAL	Alüminyum
	UZUNLUK LENGTH (m)	6
	Jx (cm ⁴)	-
	Jy (cm ⁴)	-

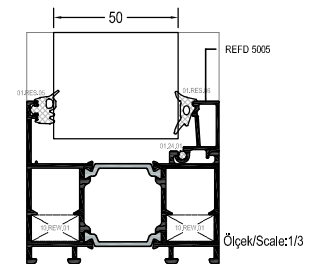

MİMARİ KATALOG
ARCHITECTURAL CATALOGUE

Alüminyum Kapı Pencere ve Giydirme Cephe Sistemleri
Aluminium Window Doors and Facade Systems

REFD77

TİPOLOJİ

TYOLOGY

SİSTEM TİPOLOJİSİ
SYSTEM TYPOLOGY

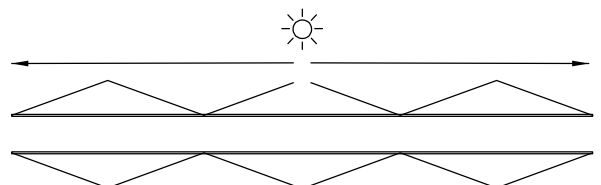
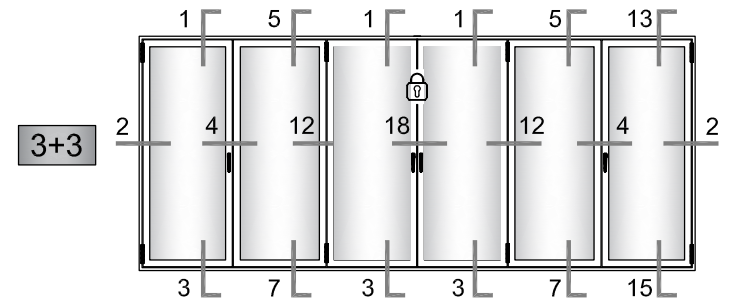
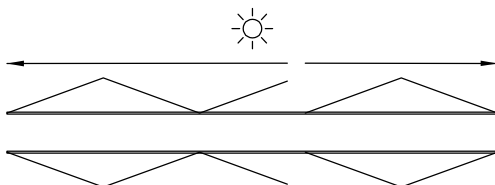
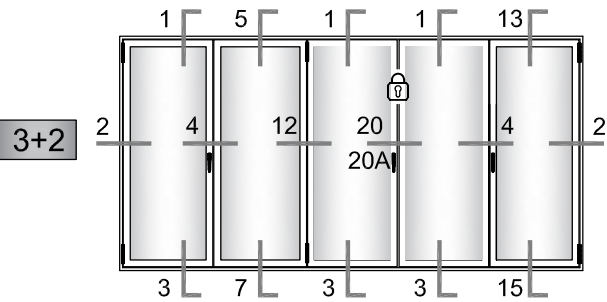
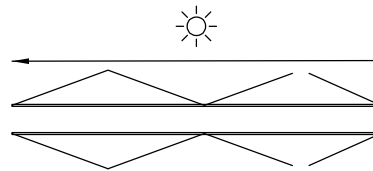
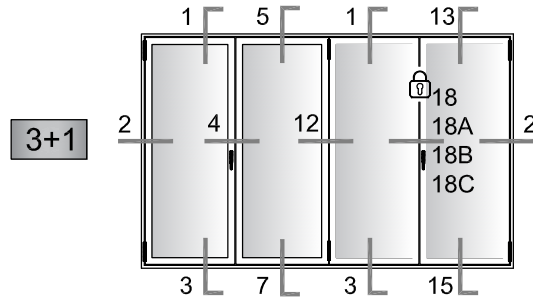
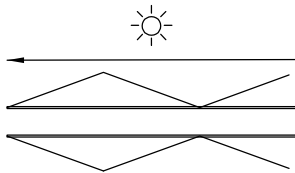
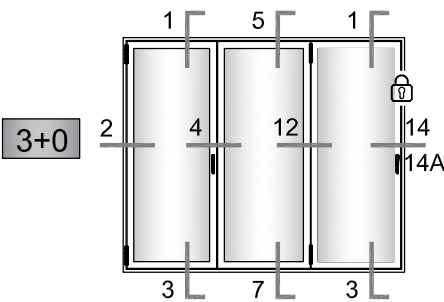
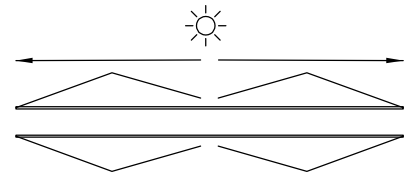
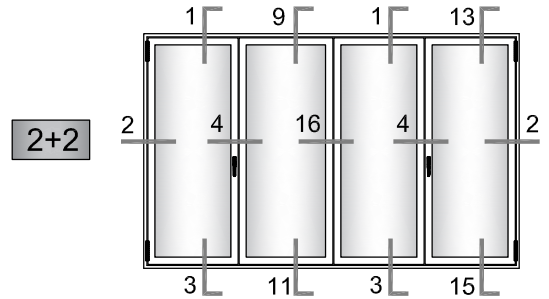
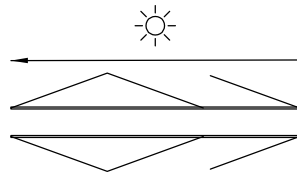
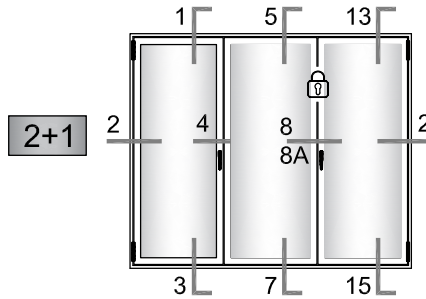
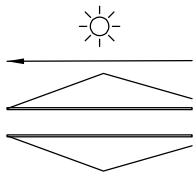
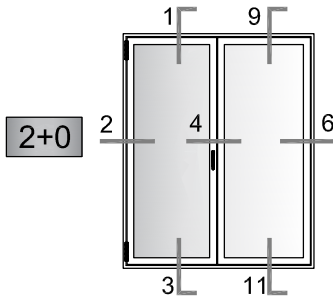

SİSTEM TİPOLOJİSİ SYSTEM TYPOLOGY

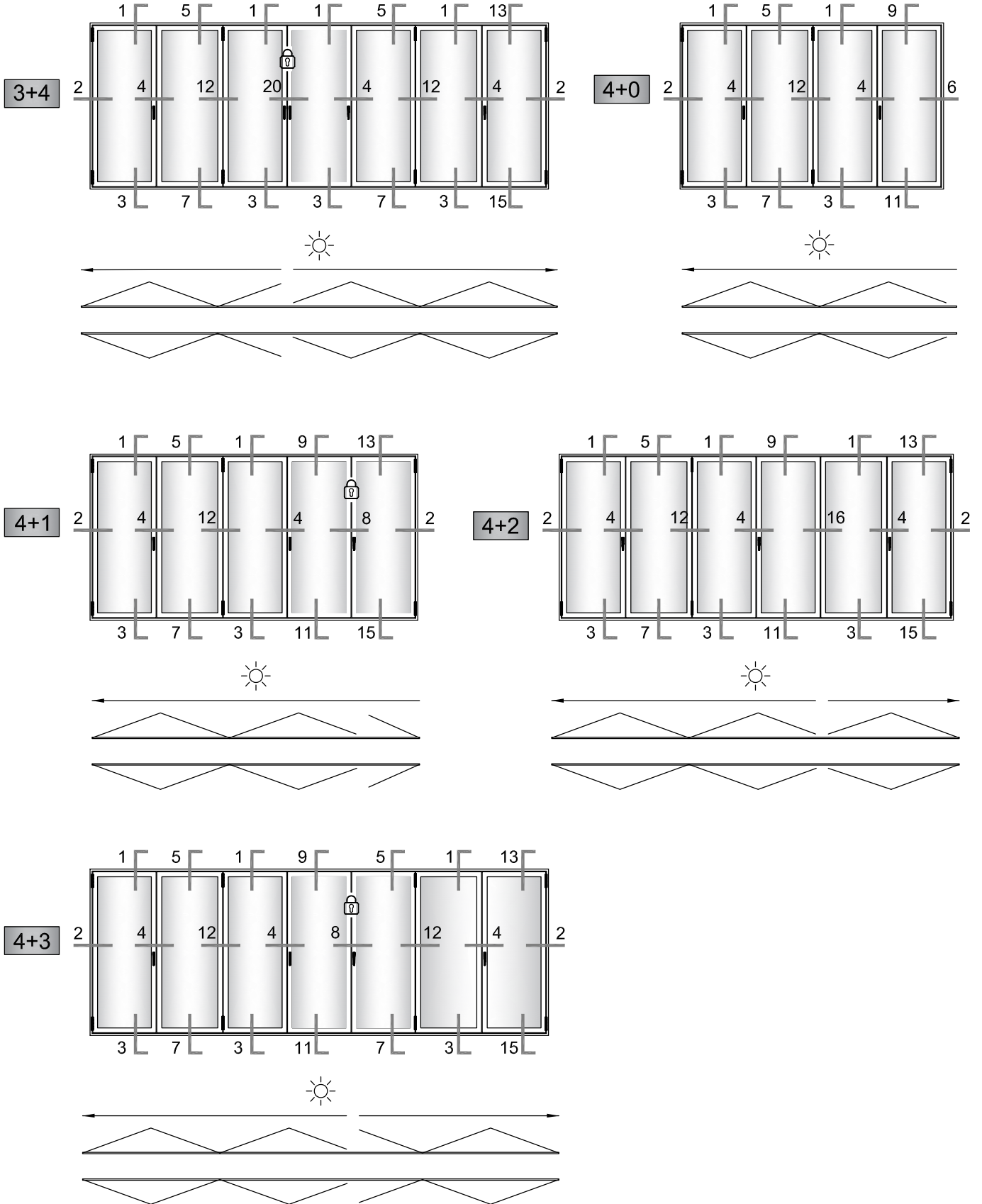

SİSTEM TİPOLOJİSİ
SYSTEM TYPOLOGY

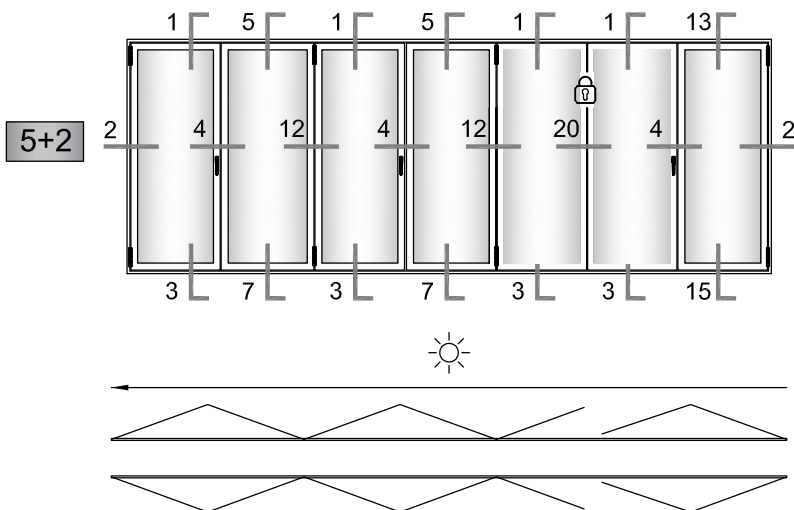
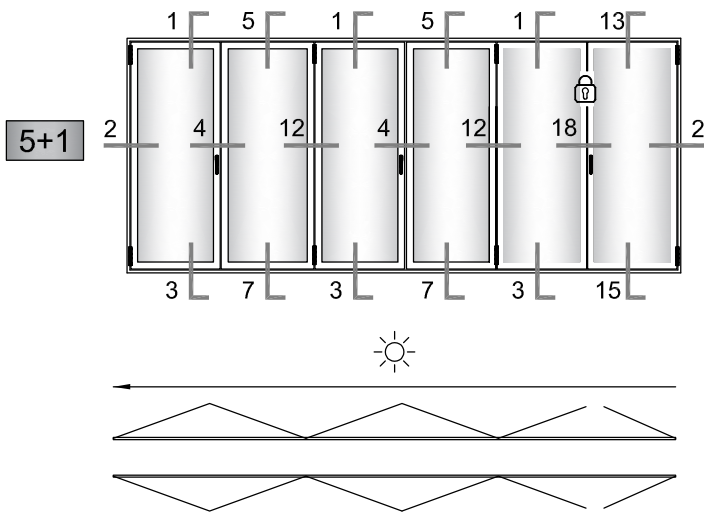
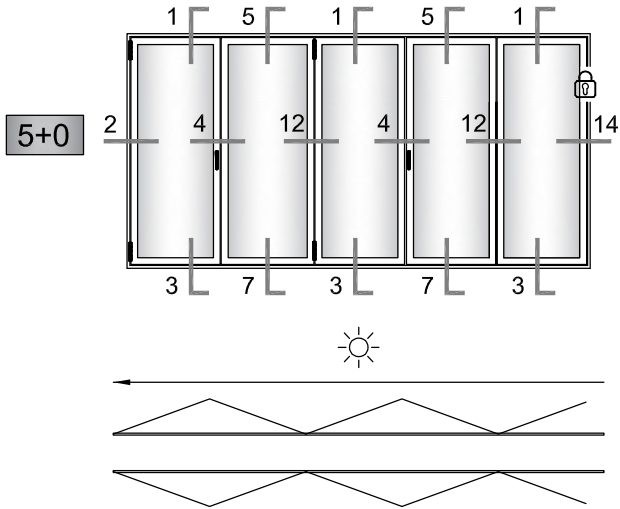

SİSTEM TİPOLOJİSİ
SYSTEM TYPOLOGY

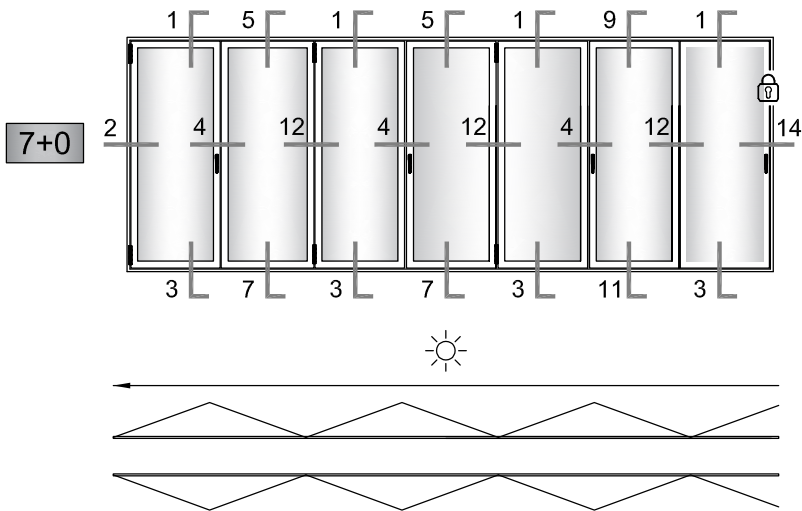
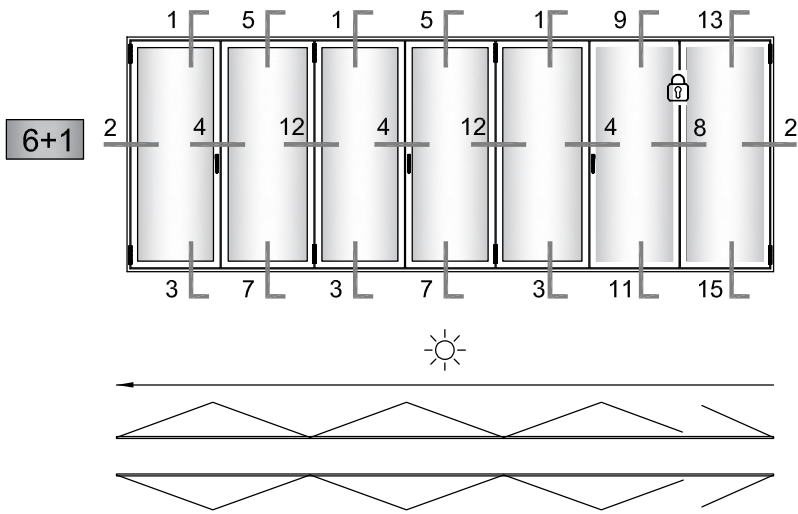
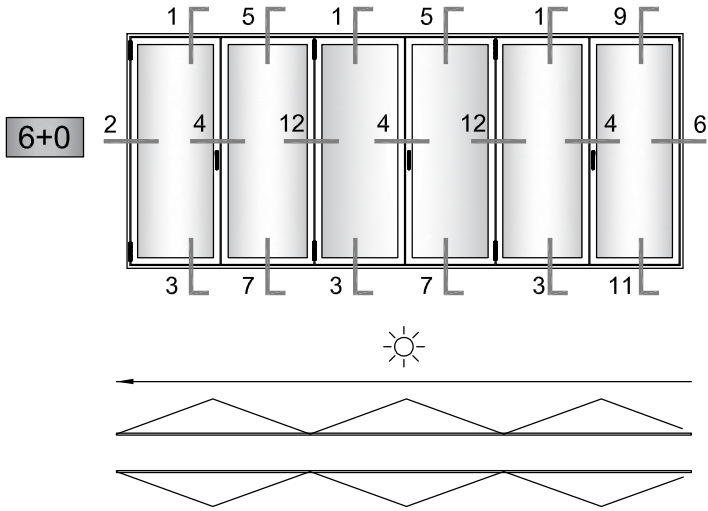

MİMARİ KATALOG
ARCHITECTURAL CATALOGUE

Alüminyum Kapı Pencere ve Giydirme Cephe Sistemleri
Aluminium Window Doors and Facade Systems

REFD77

DETAYLAR

DETAILS

DETAYLAR DETAILS

REFD77

KATLANIR KAPI İÇE AÇILIM DETAYI
FOLDING DOOR INWARD OPENING DETAIL

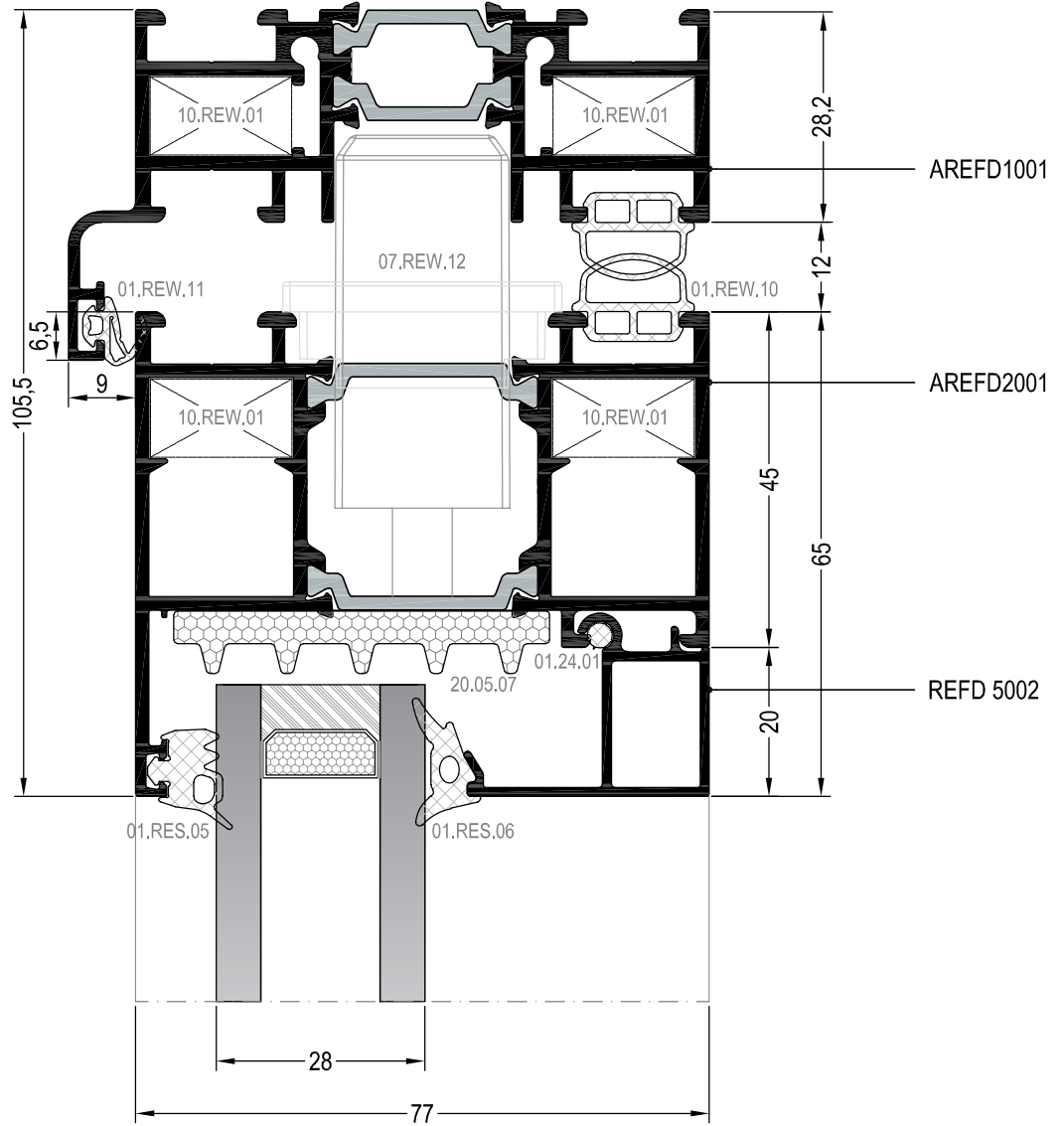
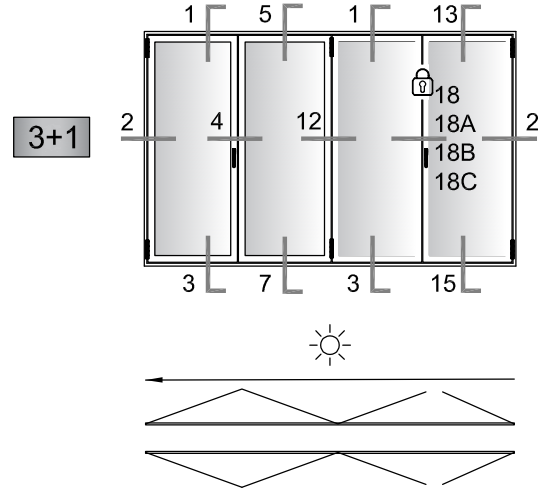

① DETAYI
DETAIL

İÇ
(INSIDE) ➔

DETAYLAR DETAILS

REFD77

KATLANIR KAPI İÇE AÇILIM DETAYI
FOLDING DOOR INWARD OPENING DETAIL

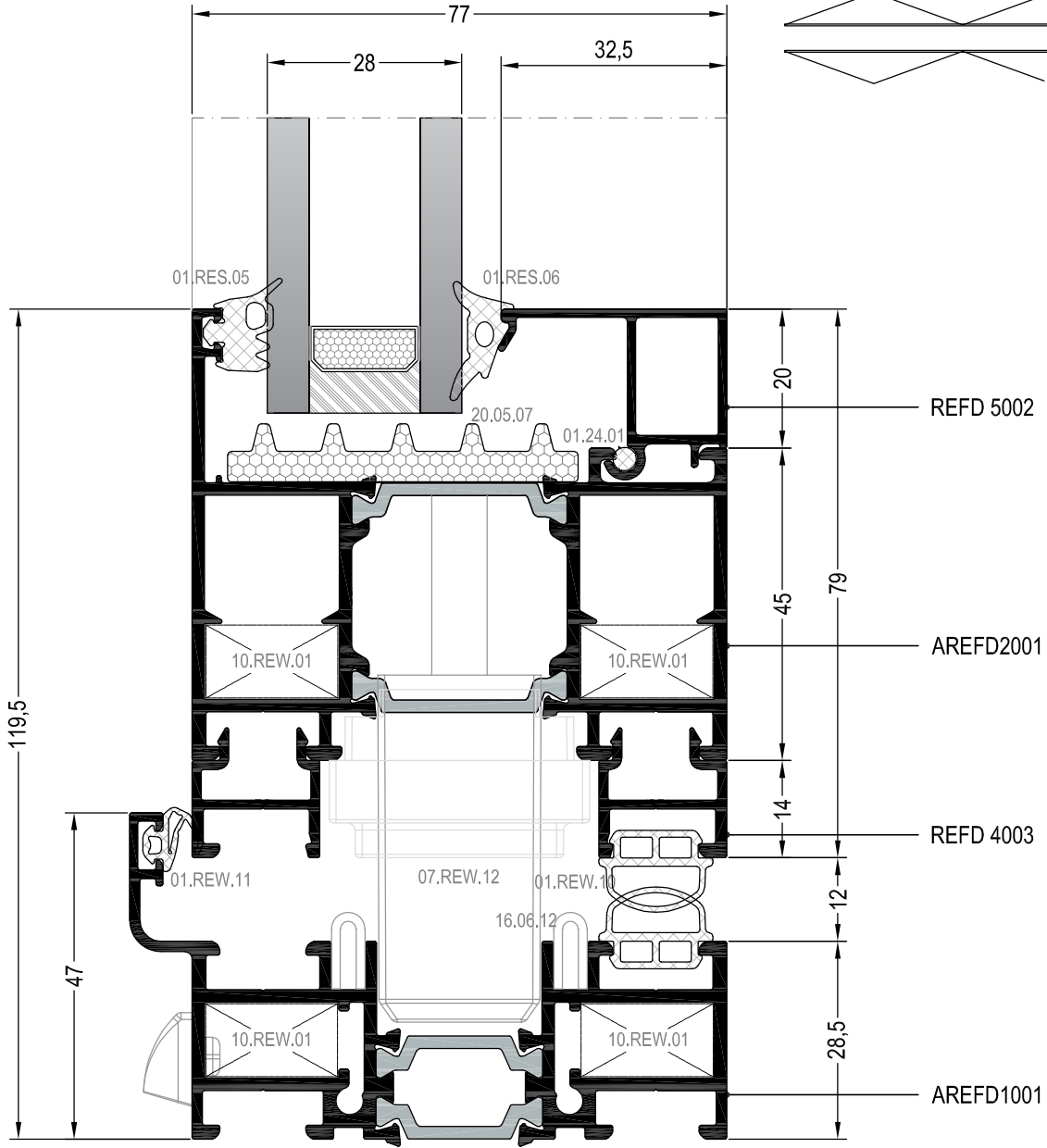
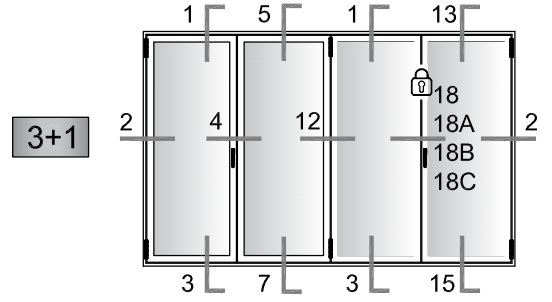

③ DETAYI
DETAIL

İÇ
(INSIDE) ➔

DETAYLAR DETAILS

REFD77

KATLANIR KAPI İÇE AÇILIM ALTERNATİF KASA DETAYI
FOLDING DOOR INWARD OPENING ALTERNATIVE FRAME DETAIL

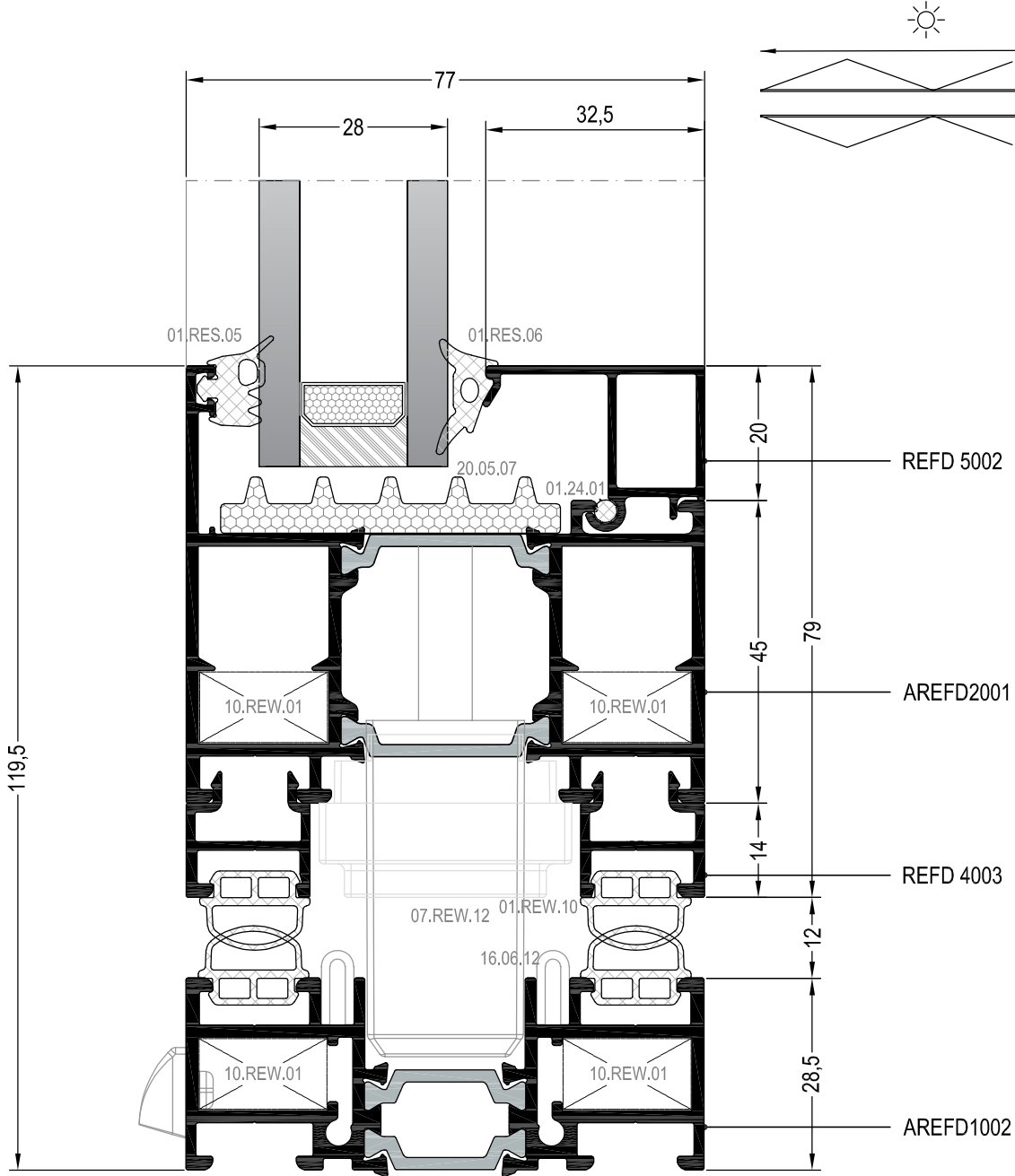
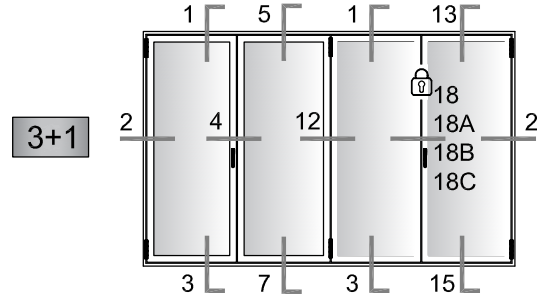

3A DETAYI
DETAIL

İÇ
(INSIDE) ➔

KATLANIR KAPI İÇE AÇILIM DETAYI
FOLDING DOOR INWARD OPENING DETAIL

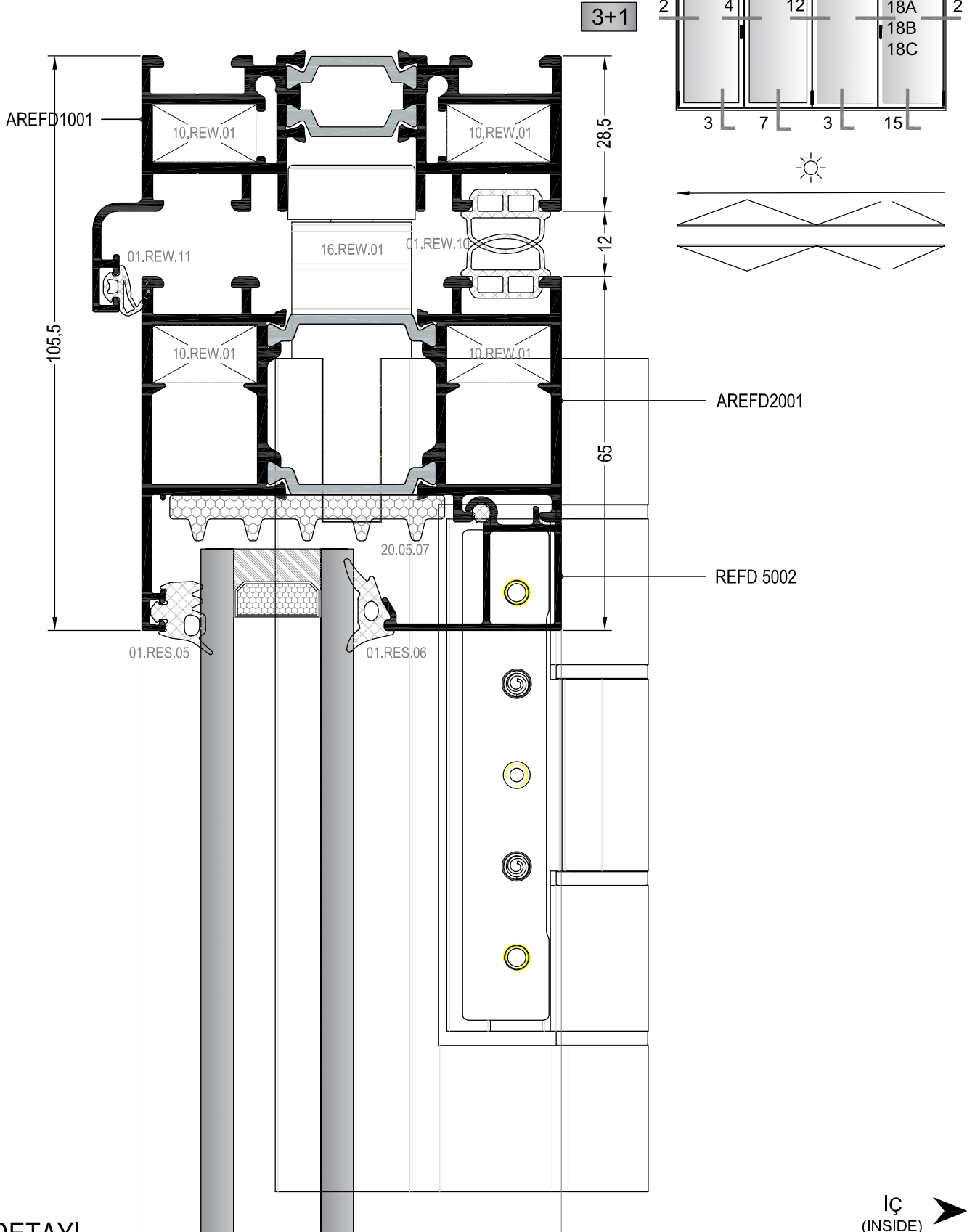

5 DETAYI
DETAIL

KATLANIR KAPI İÇE AÇILIM DETAYI
FOLDING DOOR INWARD OPENING DETAIL

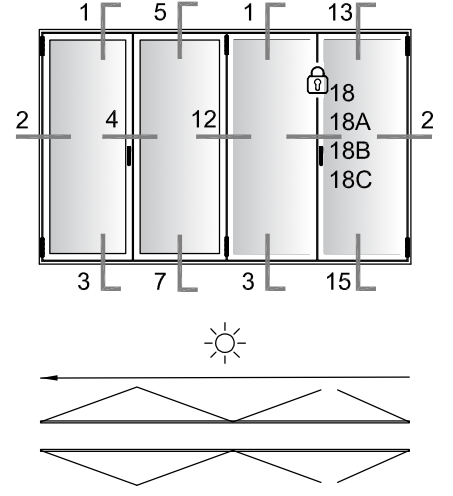
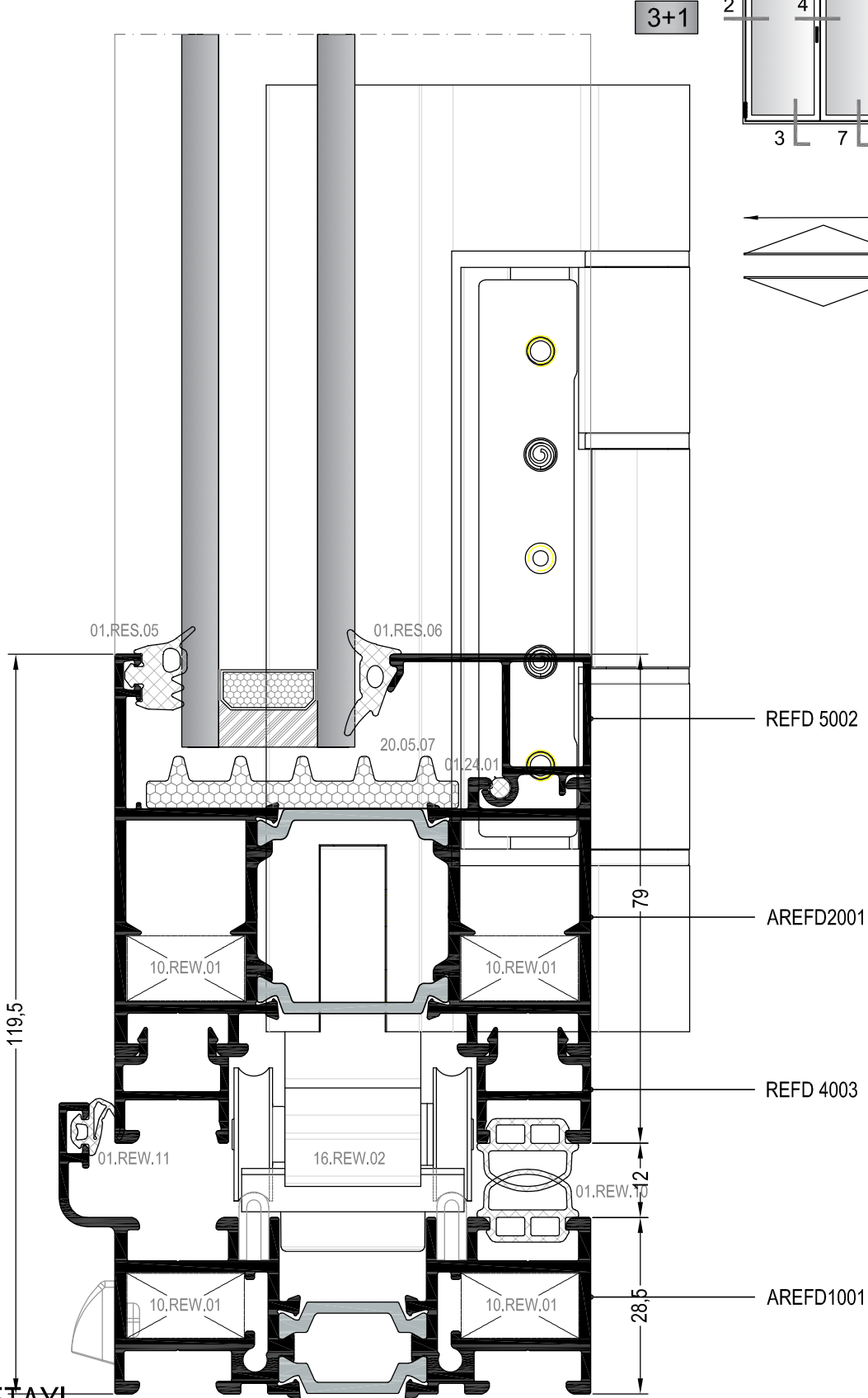

7 DETAYI
DETAIL

İÇ
(INSIDE) ➔

DETAYLAR DETAILS

REFD77

KATLANIR KAPI İÇE AÇILIM DETAYI
FOLDING DOOR INWARD OPENING DETAIL

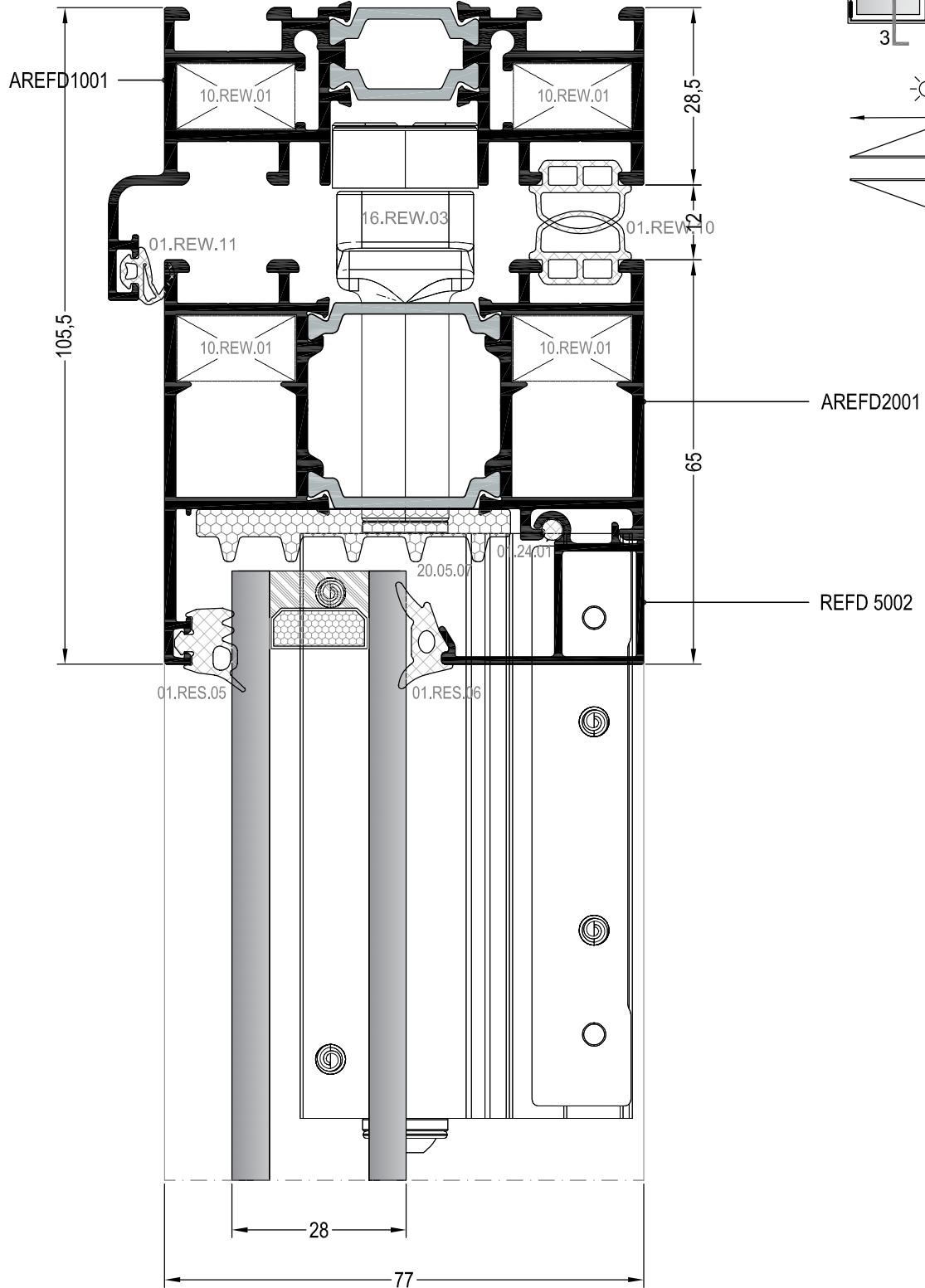

9 DETAYI
DETAIL

DETAYLAR DETAILS

REFD77

KATLANIR KAPI İÇE AÇILIM DETAYI
FOLDING DOOR INWARD OPENING DETAIL

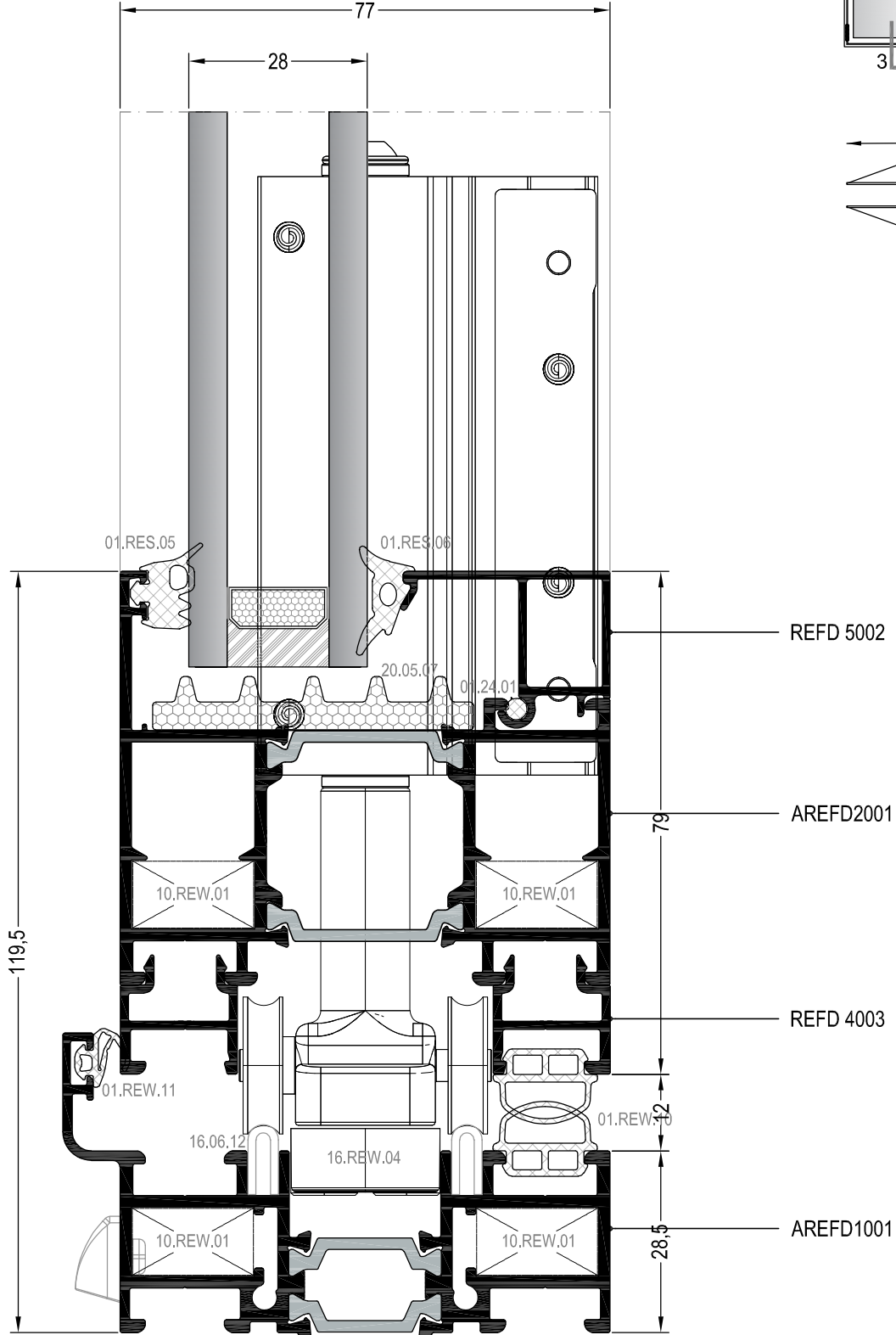
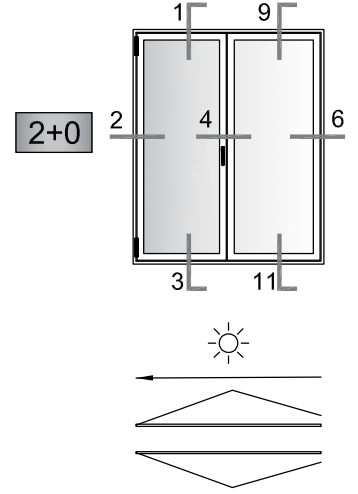

11 DETAYI
DETAIL

İÇ
(INSIDE) ➔

DETAYLAR DETAILS

REFD77

KATLANIR KAPI İÇE AÇILIM DETAYI
FOLDING DOOR INWARD OPENING DETAIL

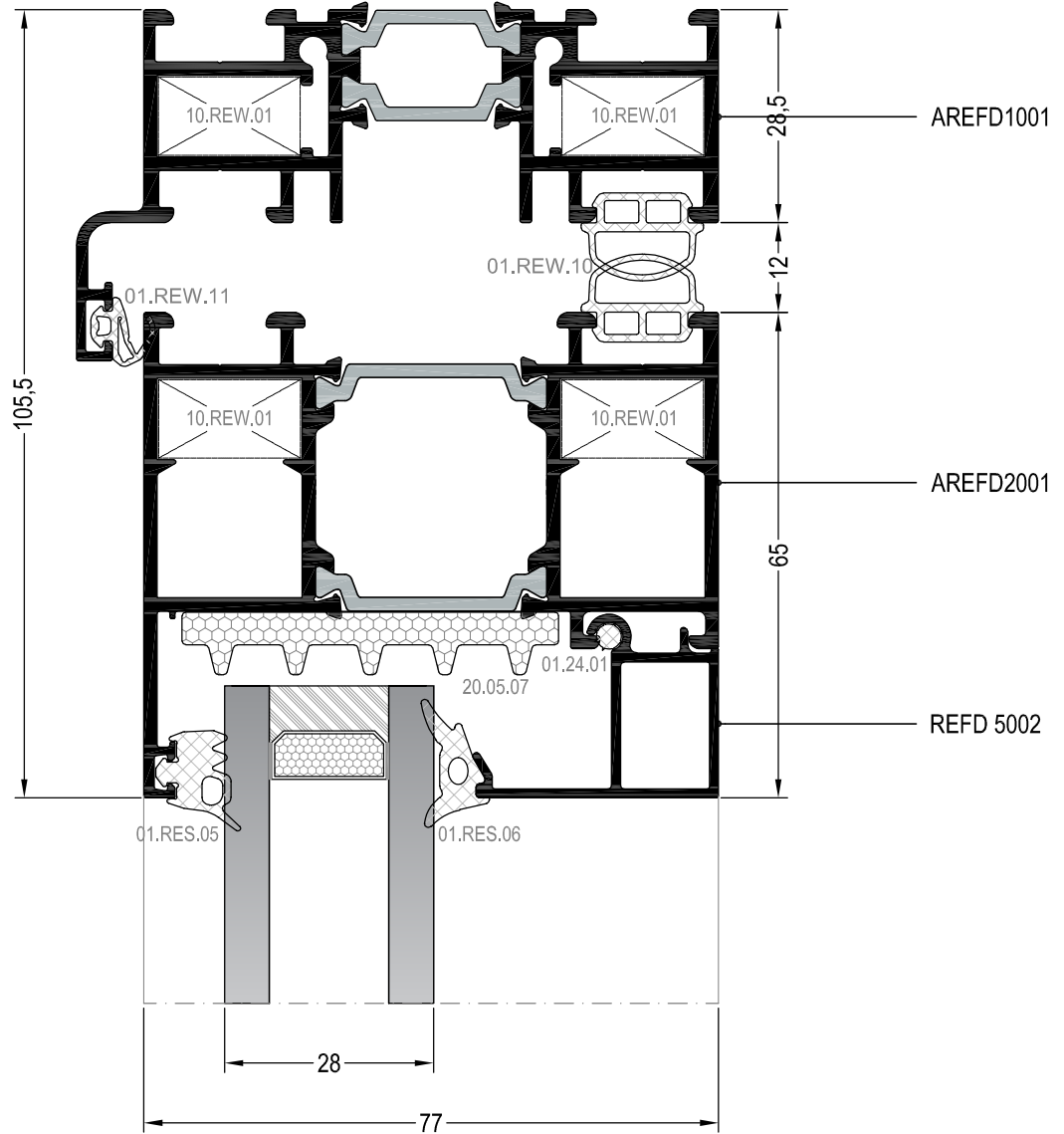
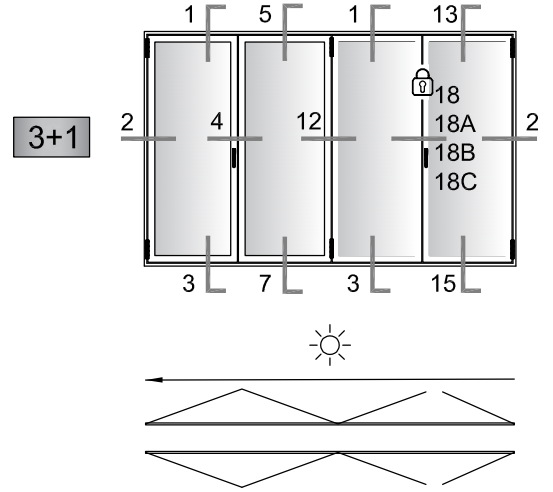

13 DETAYI
DETAIL

İÇ
(INSIDE) ➔

DETAYLAR DETAILS

REFD77

KATLANIR KAPI İÇE AÇILIM DETAYI
FOLDING DOOR INWARD OPENING DETAIL

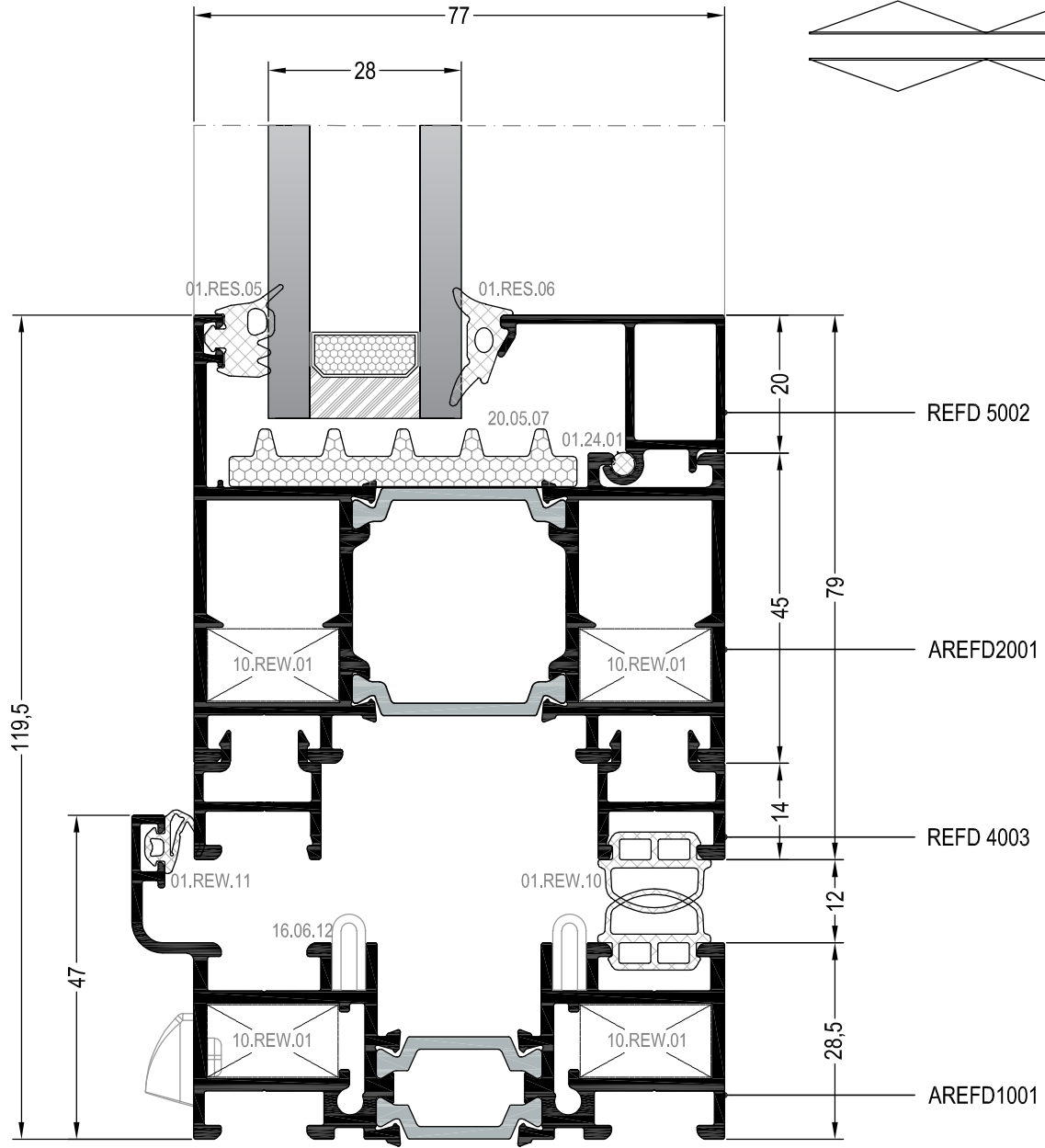
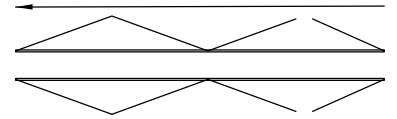
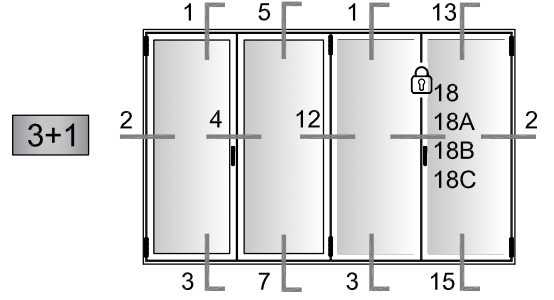

15 DETAYI
DETAIL

İÇ
(INSIDE) ➔

DETAYLAR DETAILS

REFD77

KATLANIR KAPI İÇE AÇILIM DETAYI
FOLDING DOOR INWARD OPENING DETAIL

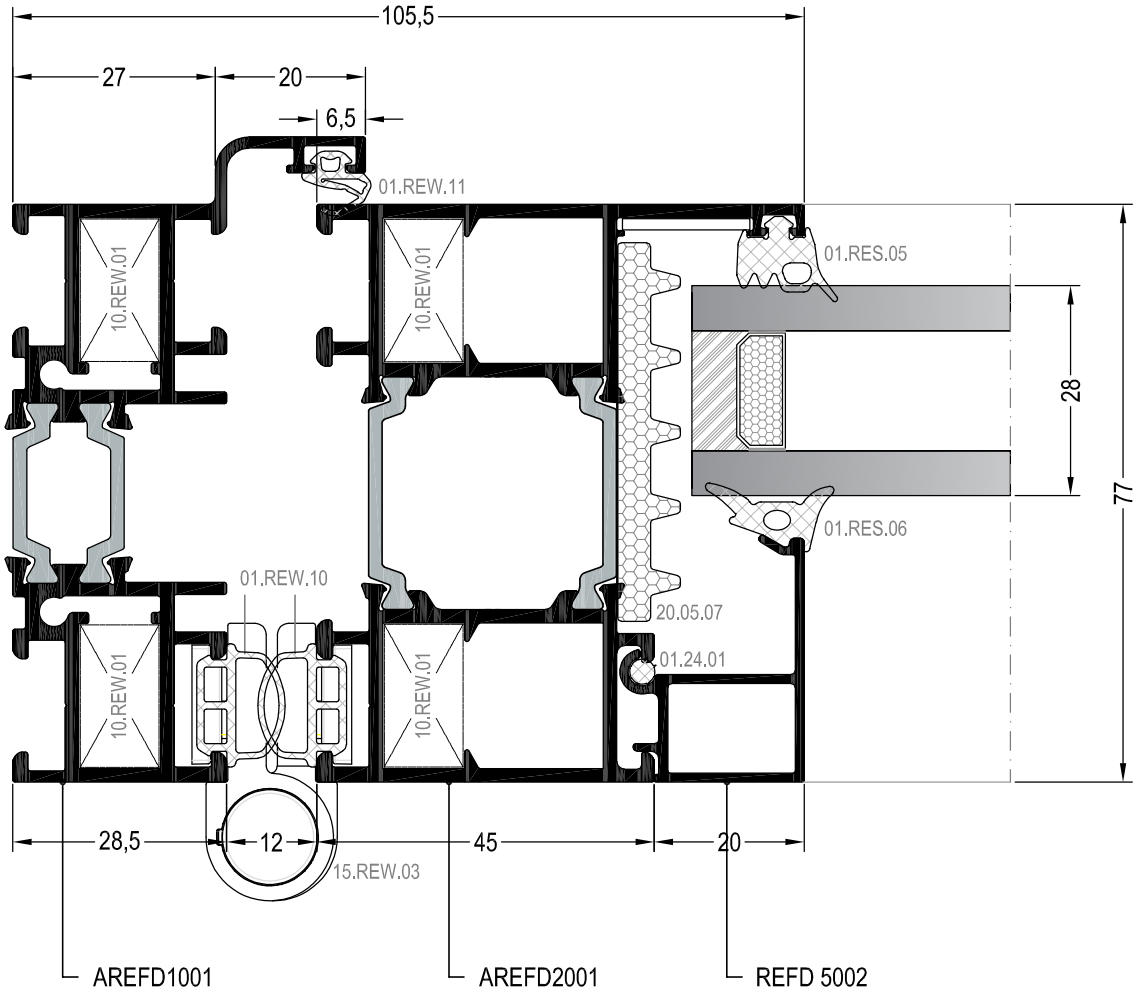
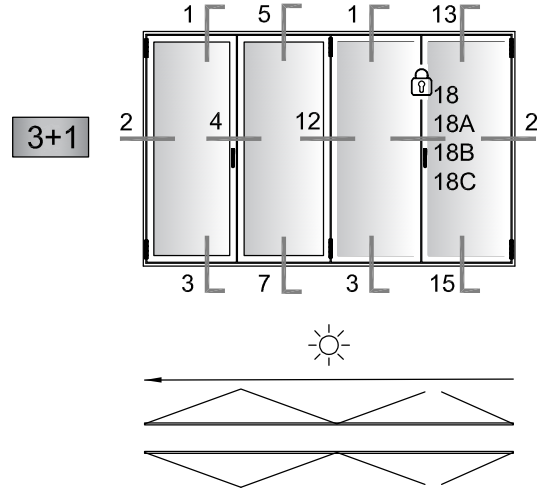

② DETAYI
DETAIL

▼ İÇ
(INSIDE)

DETAYLAR DETAILS

REFD77

KATLANIR KAPI İÇE AÇILIM DETAYI
FOLDING DOOR INWARD OPENING DETAIL

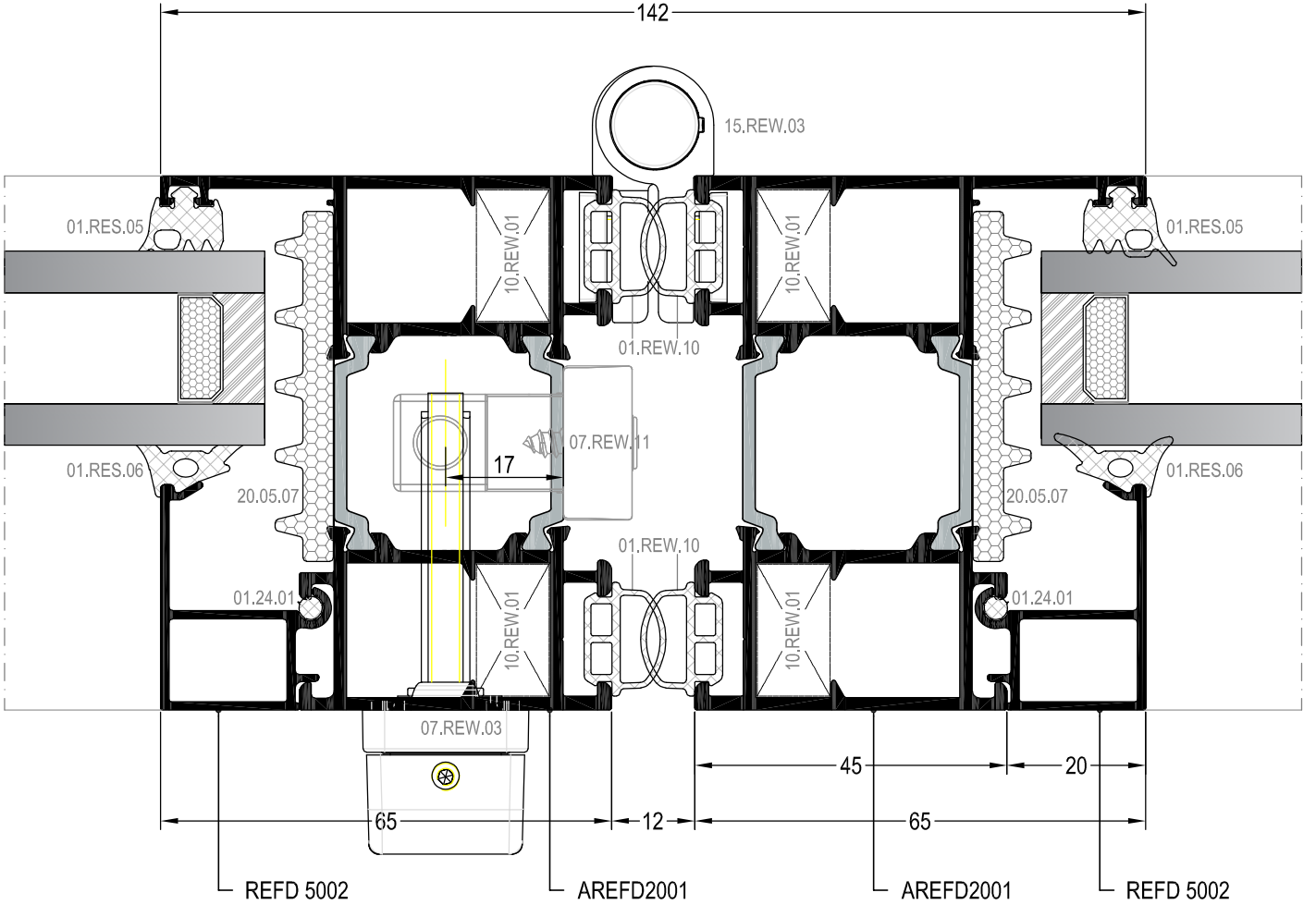
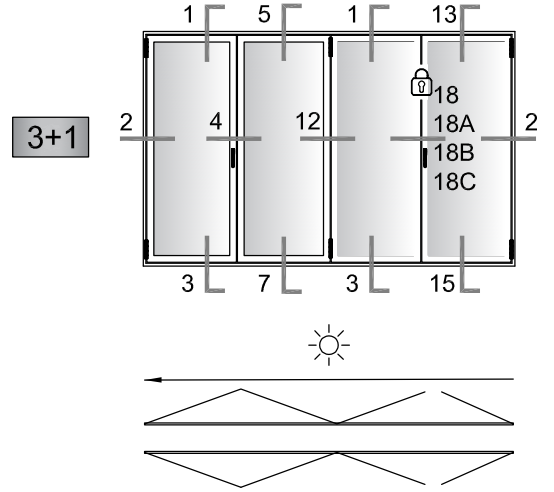

④ DETAYI
DETAIL

▼ İÇ
(INSIDE)

DETAYLAR DETAILS

REFD77

KATLANIR KAPI İÇE AÇILIM DETAYI
FOLDING DOOR INWARD OPENING DETAIL

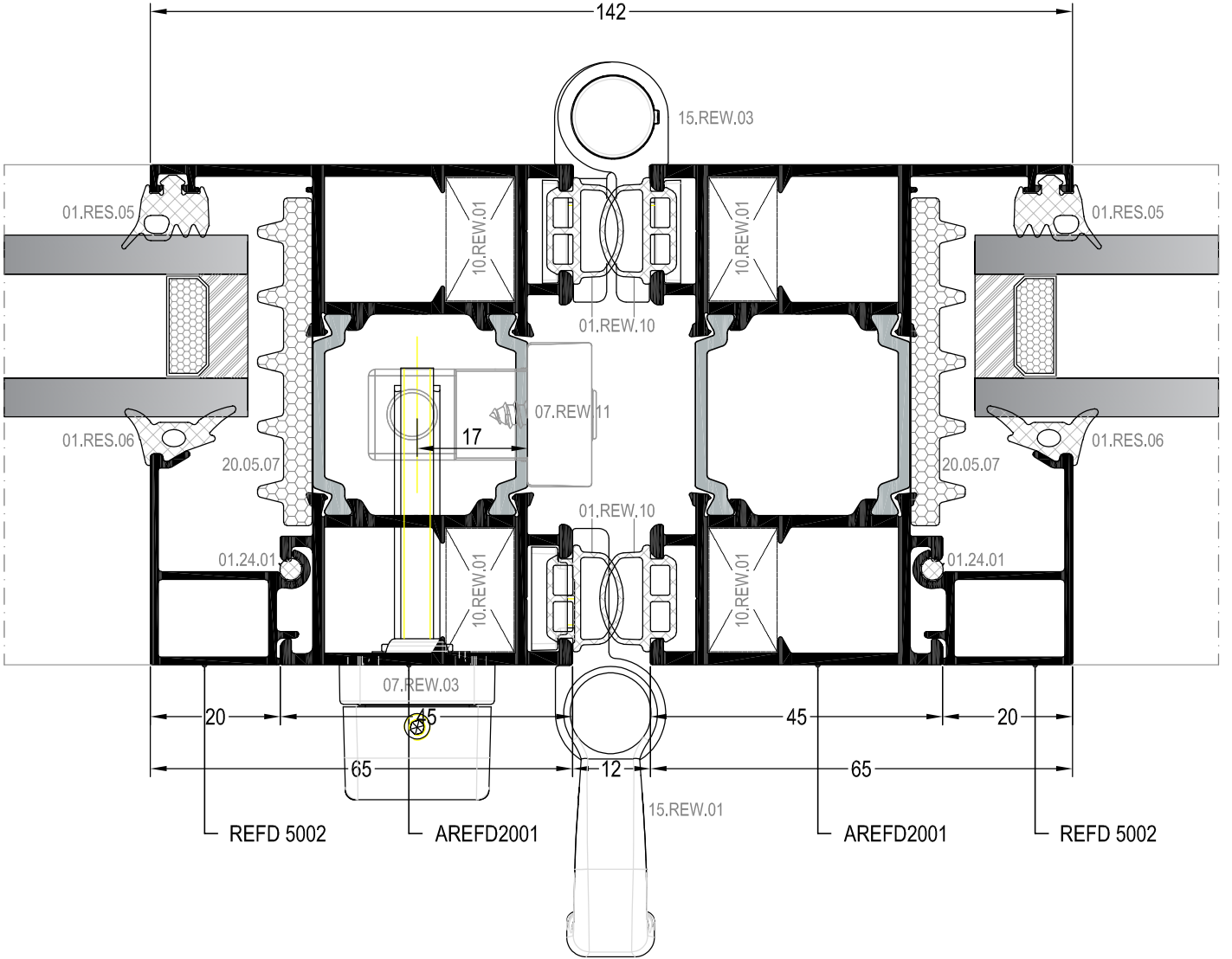
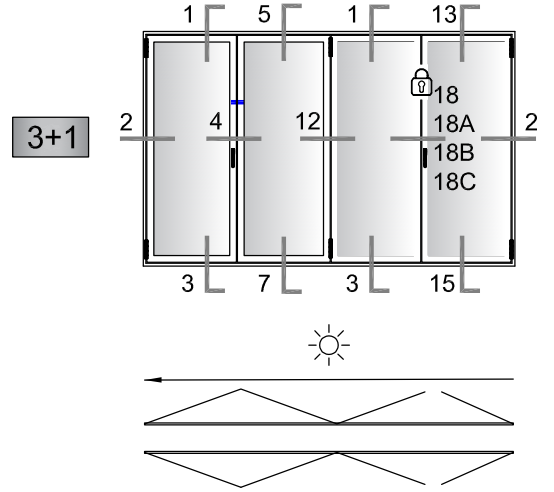

4.1 DETAYI
DETAIL

▼ İÇ
(INSIDE)

DETAYLAR DETAILS

REFD77

KATLANIR KAPI İÇE AÇILIM DETAYI
FOLDING DOOR INWARD OPENING DETAIL

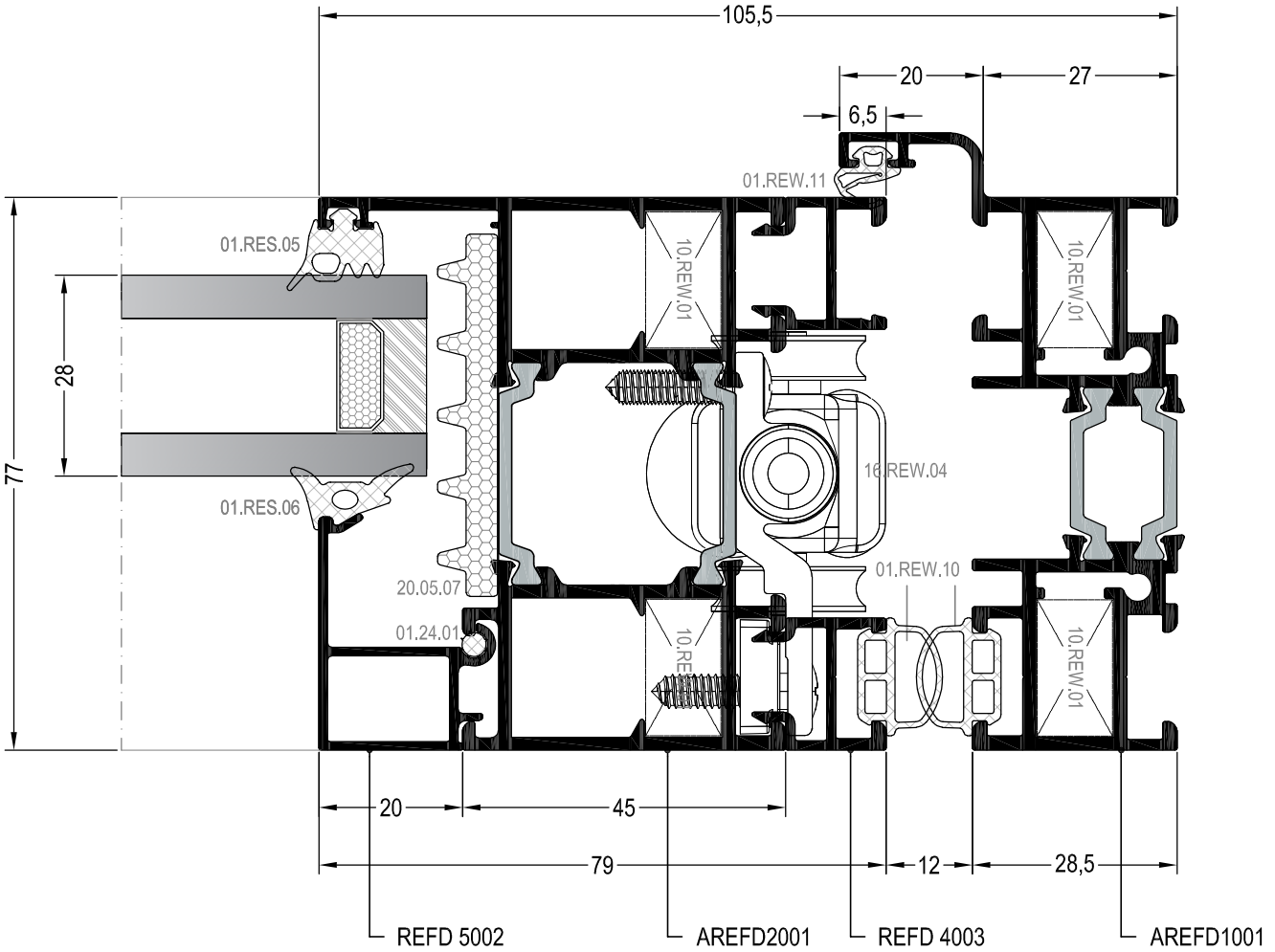
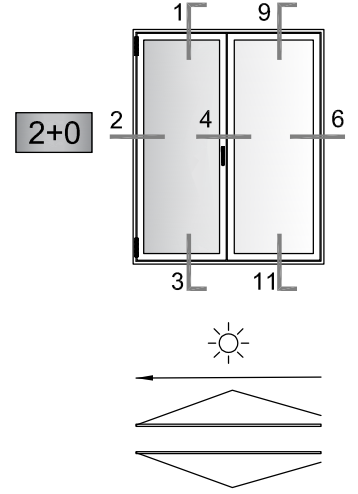

⑥ DETAYI
DETAIL

▼ İÇ
(INSIDE)

DEAYLAR DETAILS

REFD77

KATLANIR KAPI İÇE AÇILIM DETAYI
FOLDING DOOR INWARD OPENING DETAIL

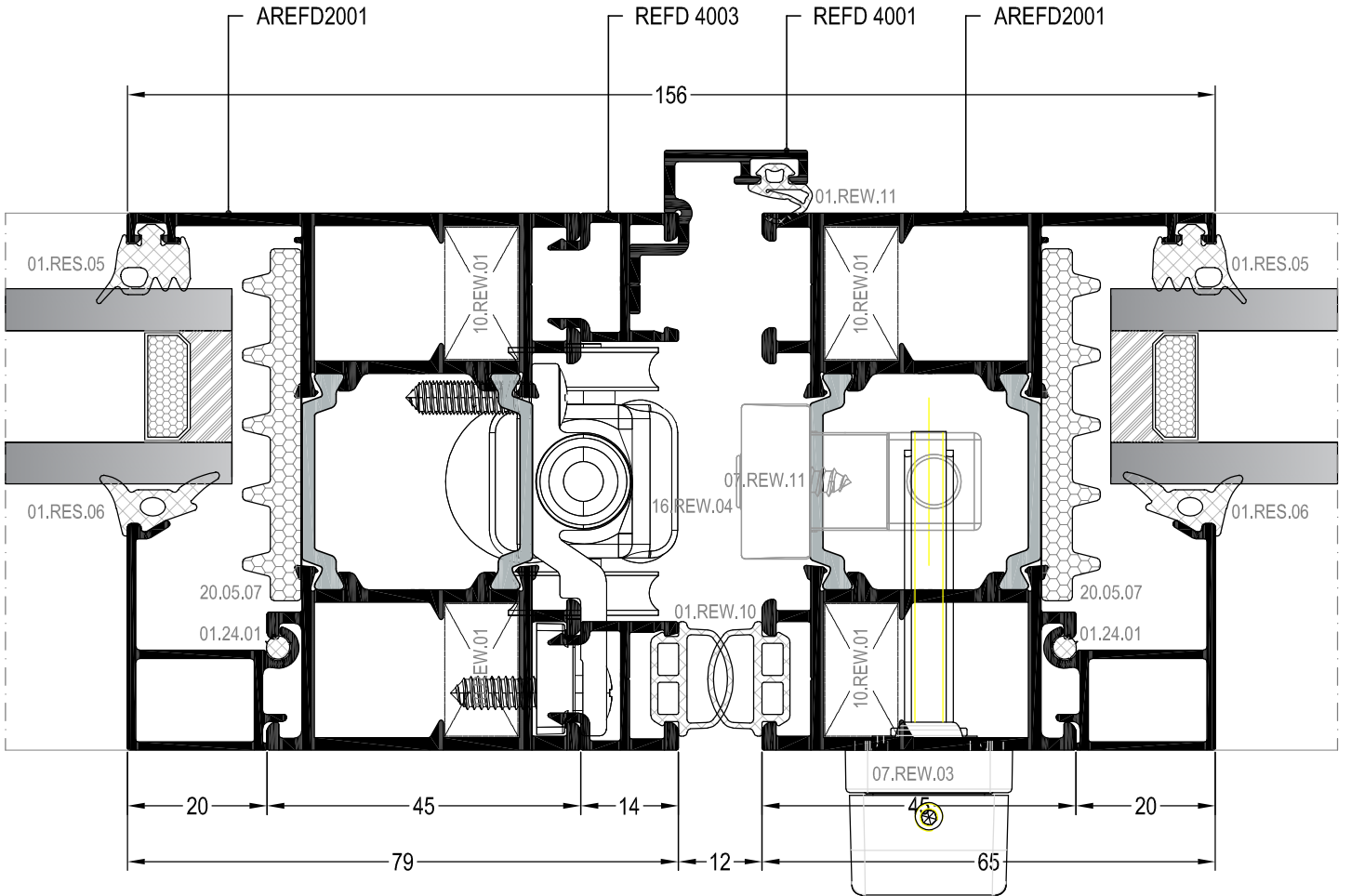
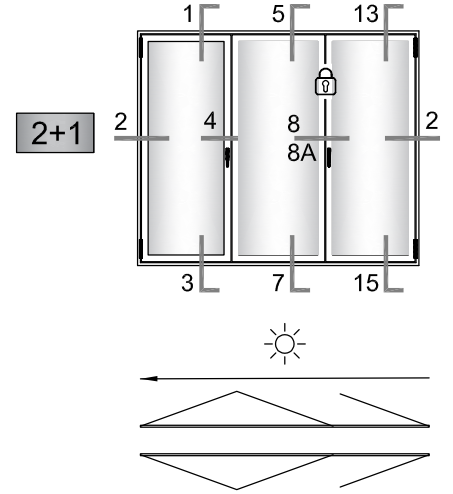

8 DETAYI
DETAIL

▼ İÇ
(INSIDE)

DETAYLAR DETAILS

REFD77

KATLANIR KAPI İÇE AÇILIM DETAYI
FOLDING DOOR INWARD OPENING DETAIL

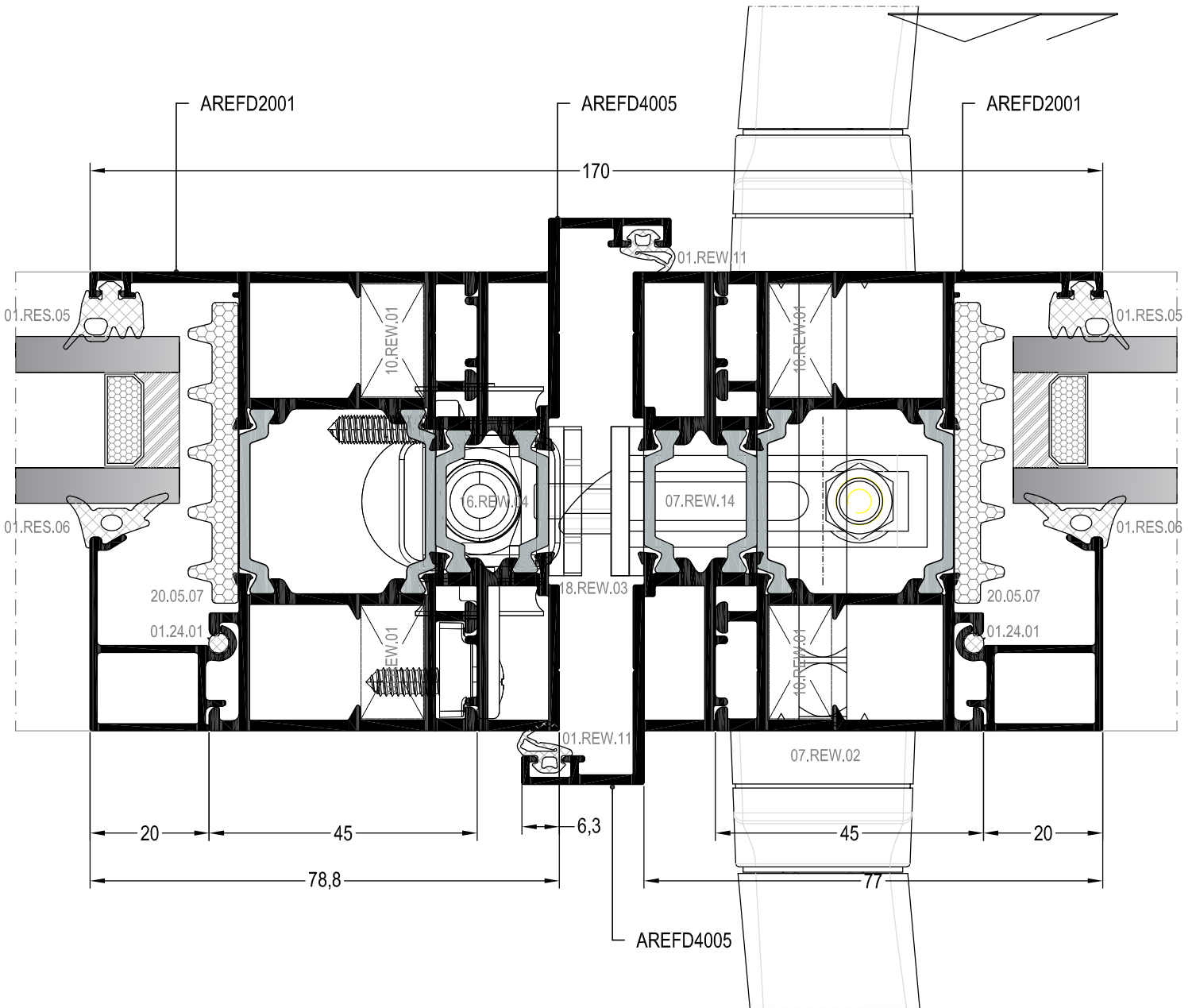
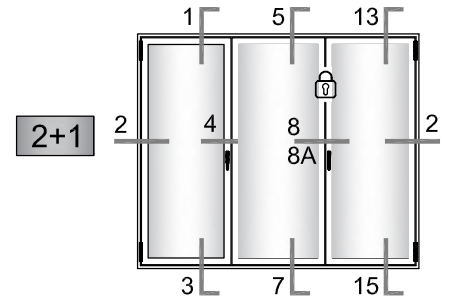

8A DETAYI
DETAIL

▼ İÇ
(INSIDE)

DETAYLAR DETAILS

REFD77

KATLANIR KAPI İÇE AÇILIM DETAYI
FOLDING DOOR INWARD OPENING DETAIL

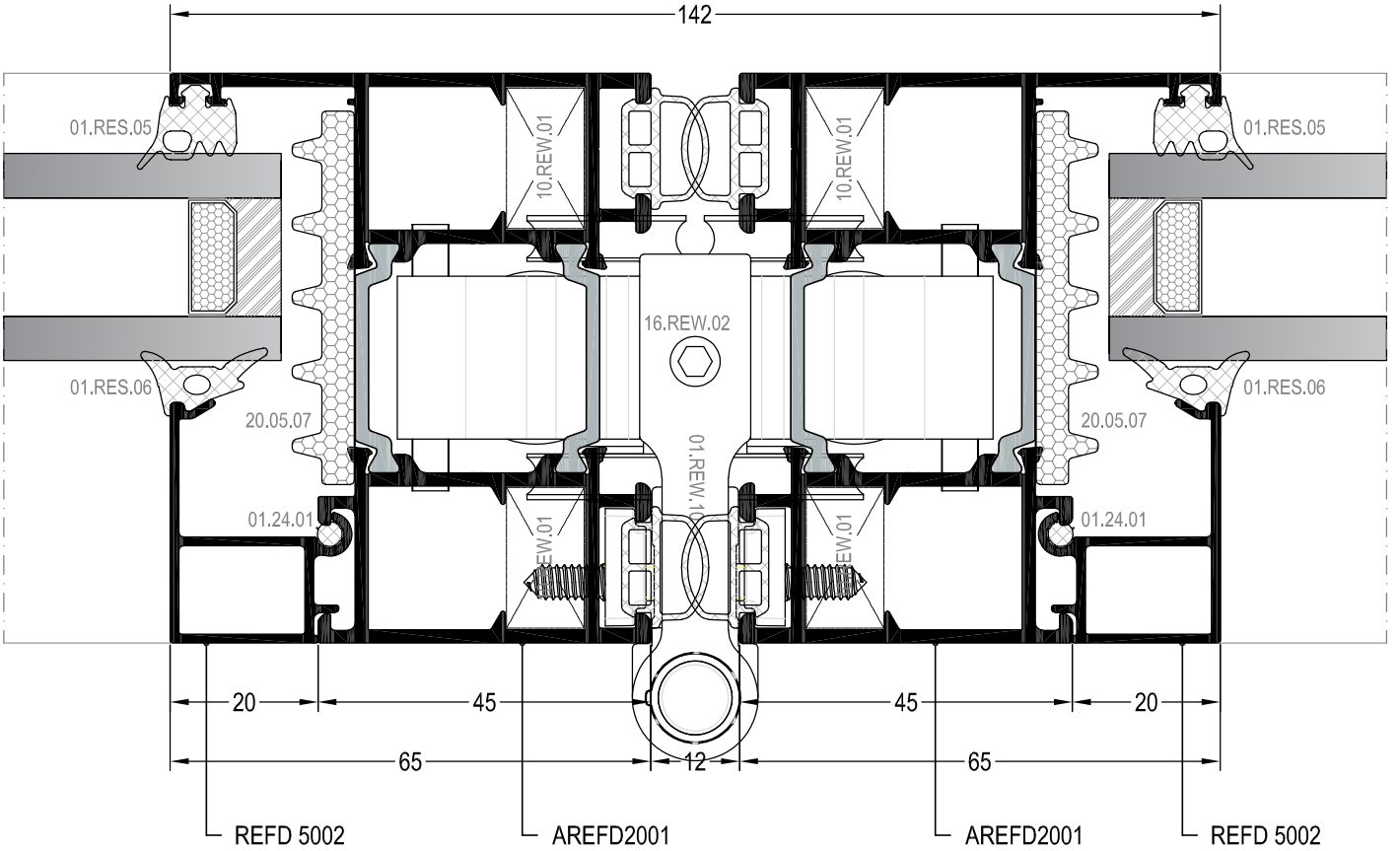
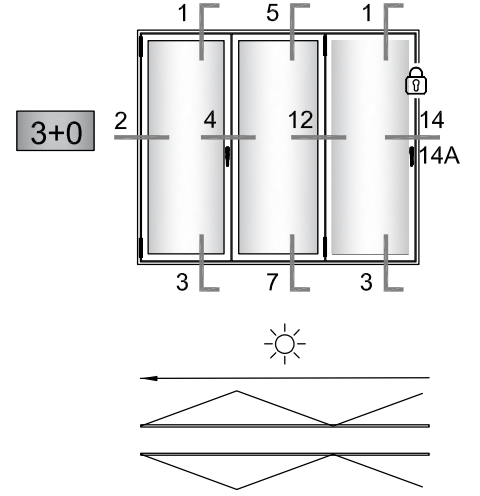

12 DETAYI
DETAIL

▼ İÇ
(INSIDE)

DEAYLAR DETAILS

REFD77

KATLANIR KAPI İÇE AÇILIM DETAYI
FOLDING DOOR INWARD OPENING DETAIL

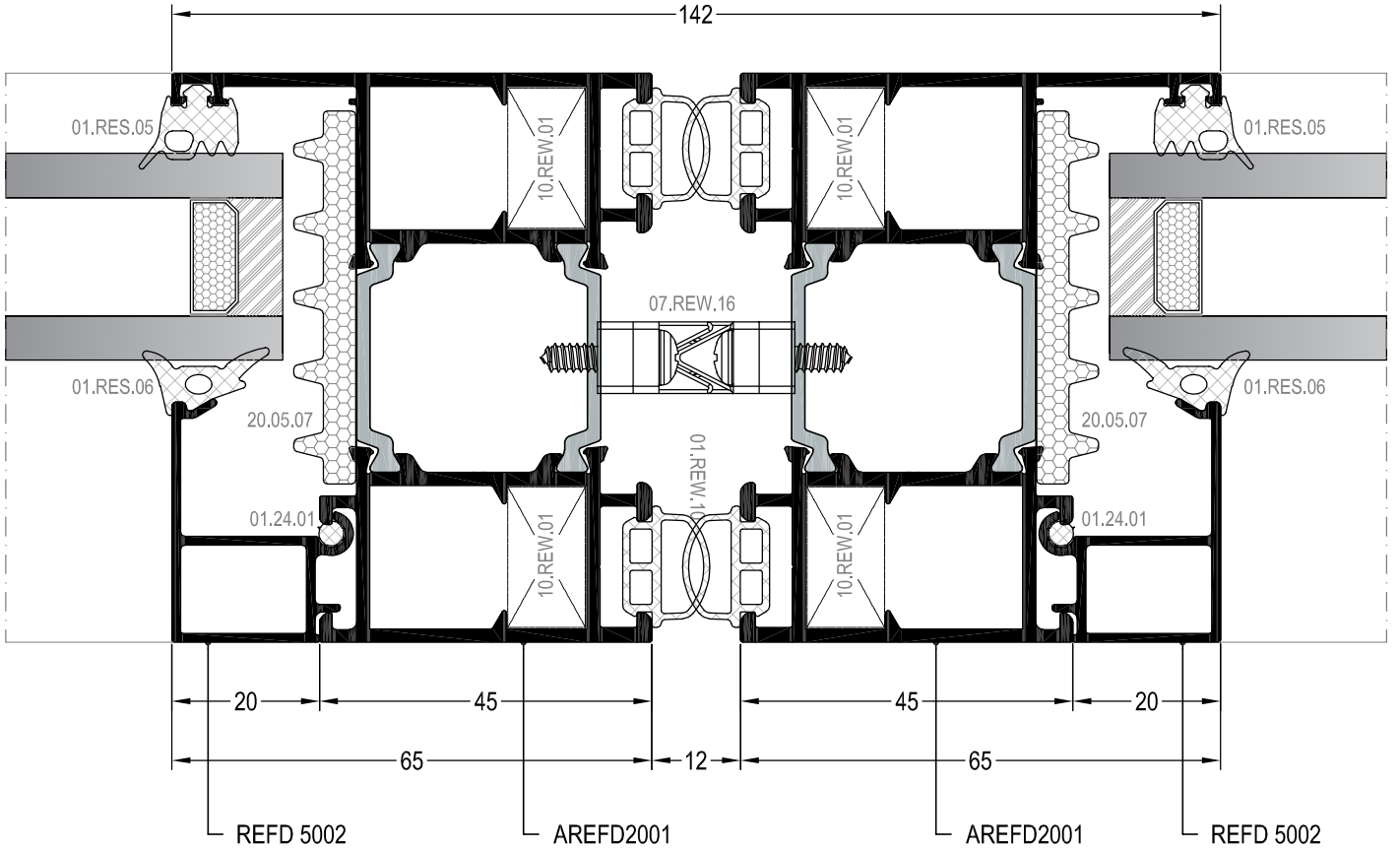
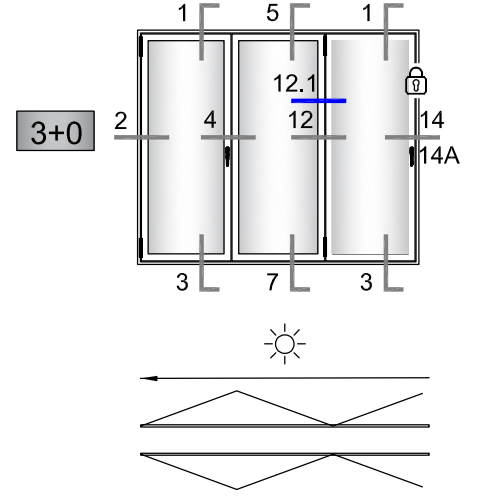

12.1 DETAYI
DETAIL

▼ İÇ
(INSIDE)

DETAYLAR DETAILS

REFD77

KATLANIR KAPI İÇE AÇILIM DETAYI
FOLDING DOOR INWARD OPENING DETAIL

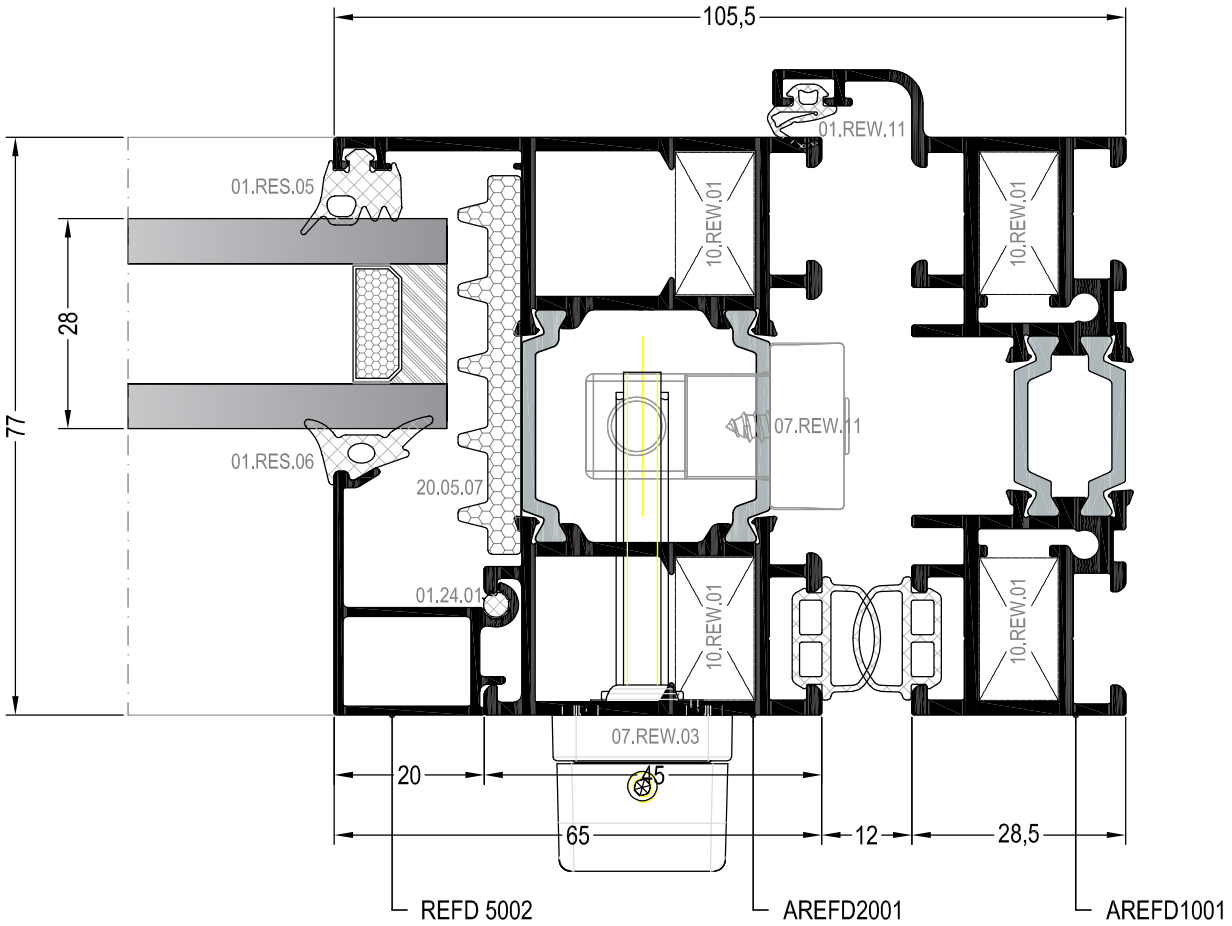
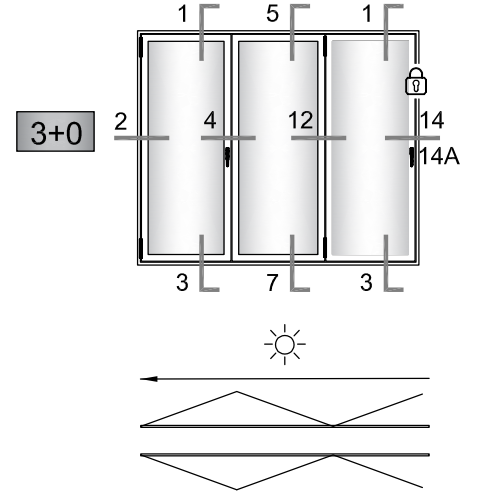

14 DETAYI
DETAIL

▼ İÇ
(INSIDE)

DETAYLAR DETAILS

REFD77

KATLANIR KAPI İÇE AÇILIM DETAYI
FOLDING DOOR INWARD OPENING DETAIL

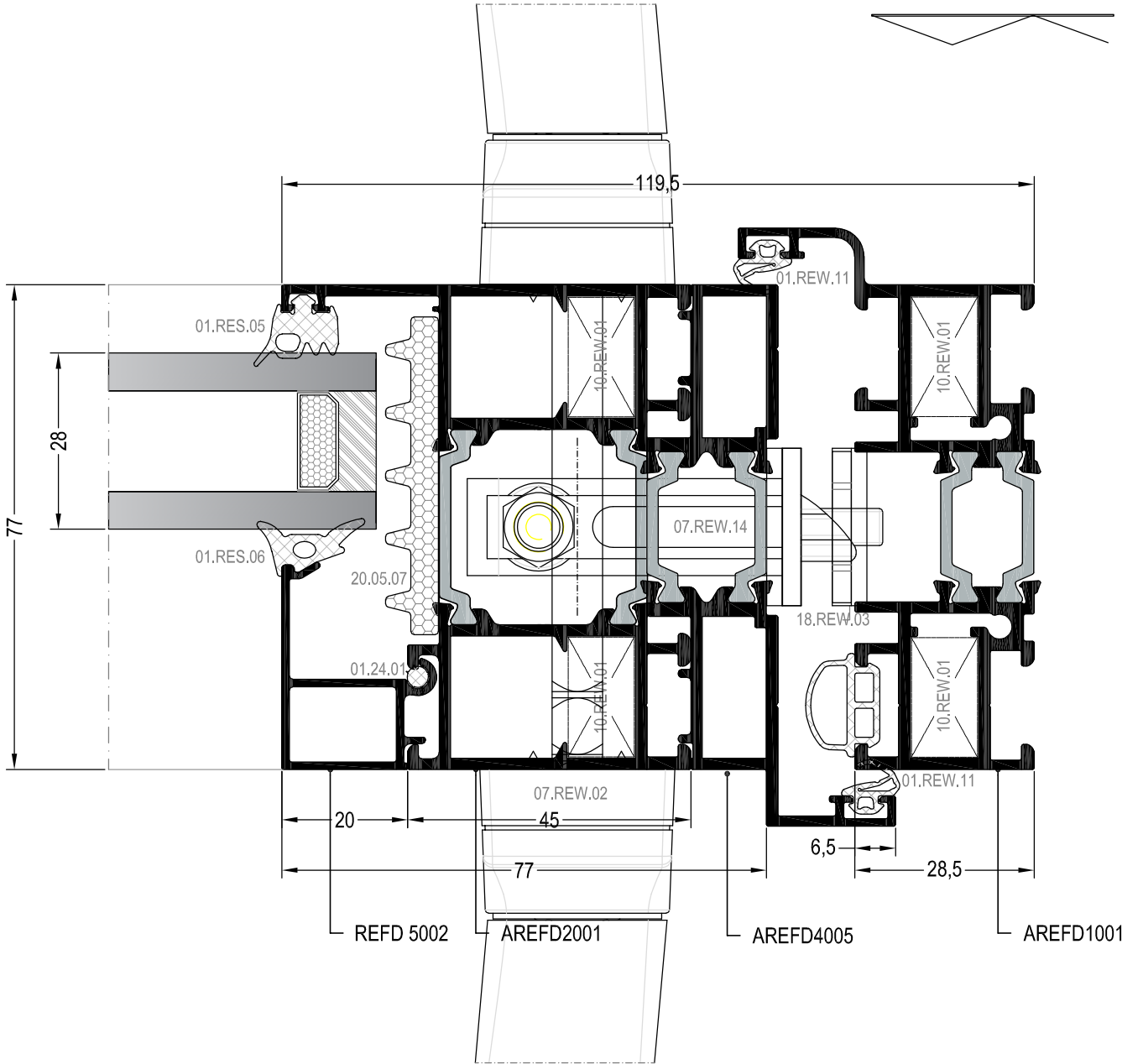
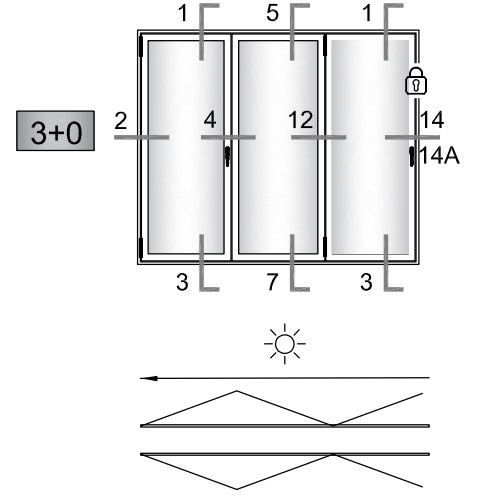

14A

DETAYI
DETAIL

▼ İÇ
(INSIDE)

DETAYLAR DETAILS

REFD77

KATLANIR KAPI İÇE AÇILIM DETAYI
FOLDING DOOR INWARD OPENING DETAIL

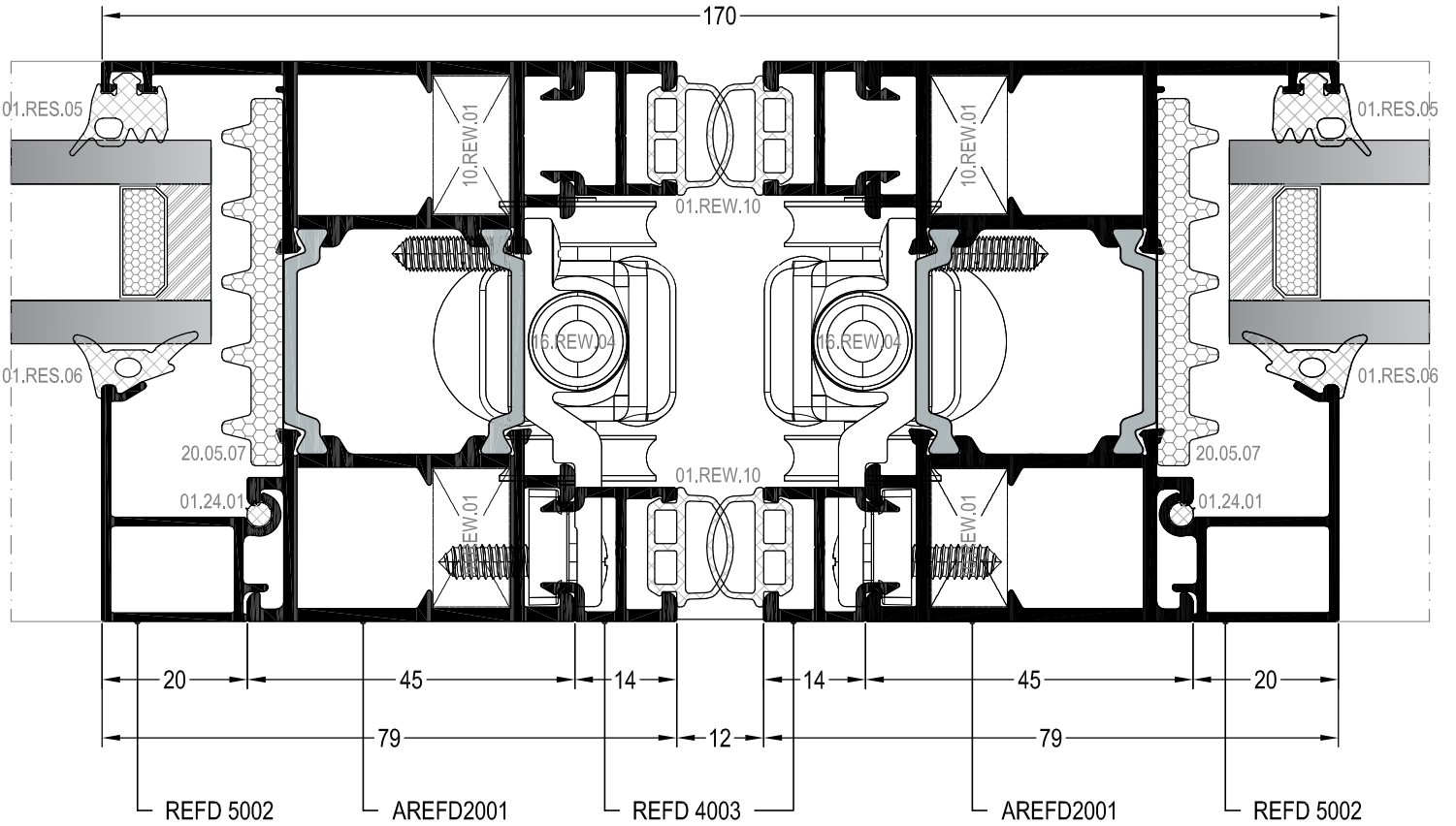
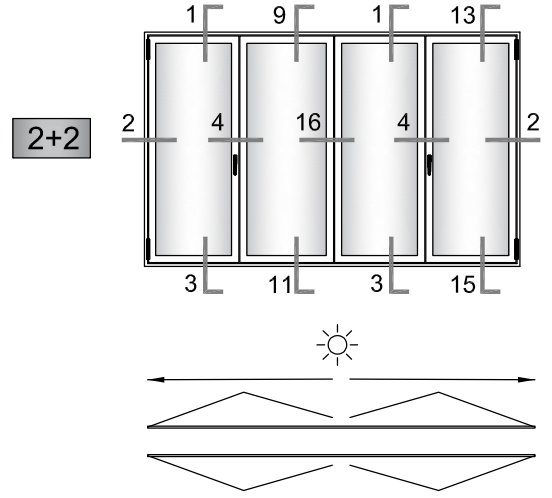

16 DETAYI
DETAIL

▼ İÇ
(INSIDE)

DEAYLAR DETAILS

REFD77

KATLANIR KAPI İÇE AÇILIM DETAYI
FOLDING DOOR INWARD OPENING DETAIL

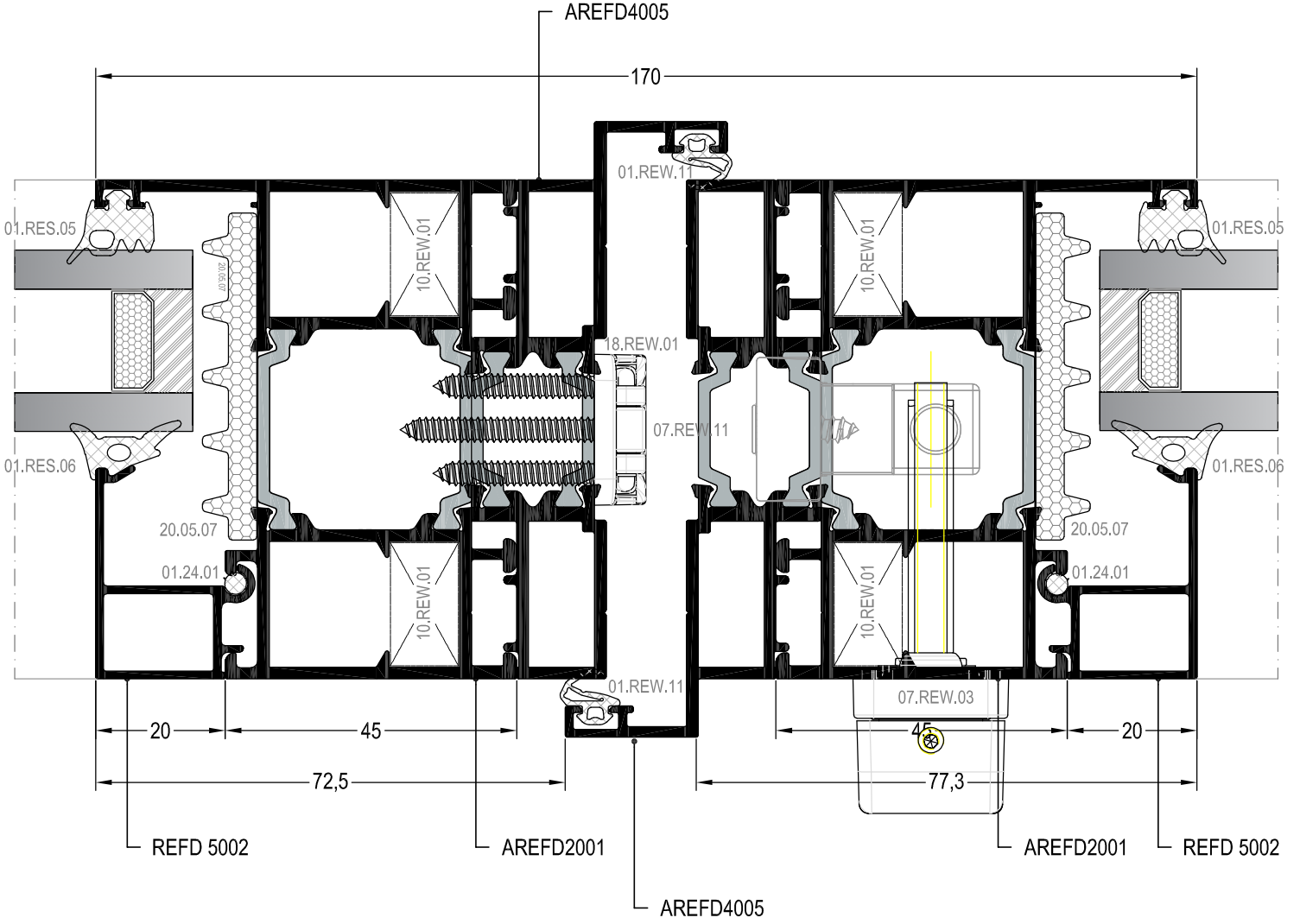
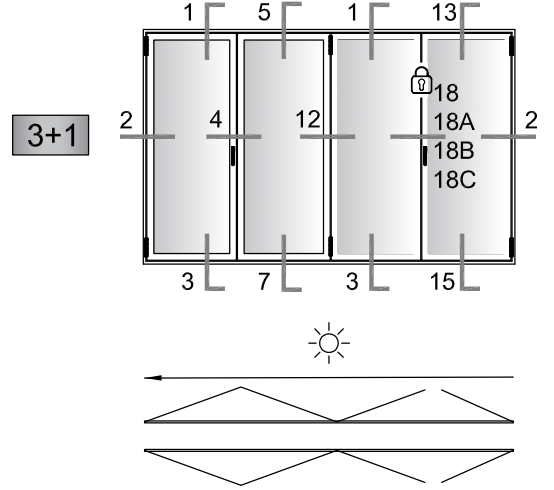

18 DETAYI
DETAIL

▼ İÇ
(INSIDE)

DEAYLAR DETAILS

REFD77

KATLANIR KAPI İÇE AÇILIM DETAYI
FOLDING DOOR INWARD OPENING DETAIL

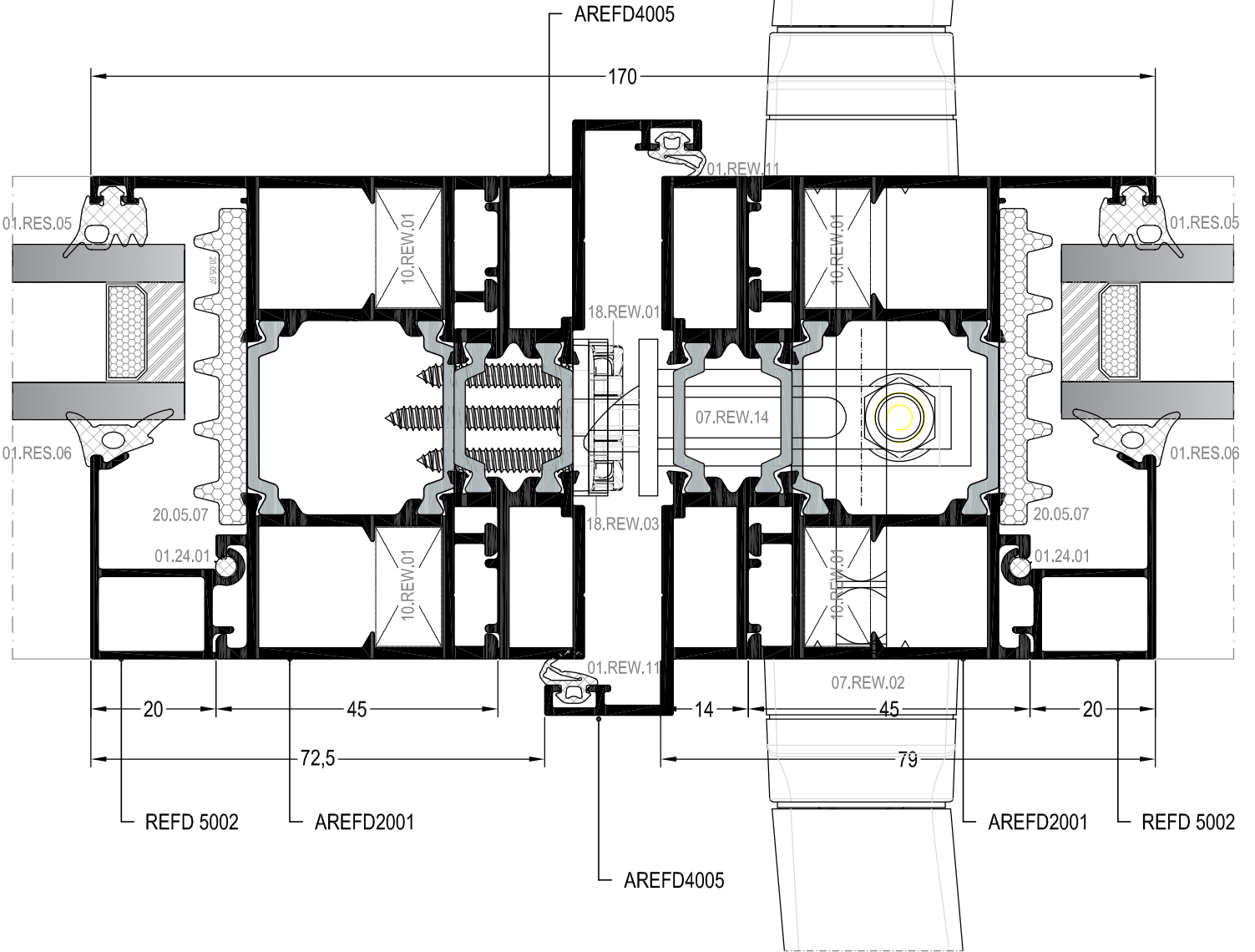
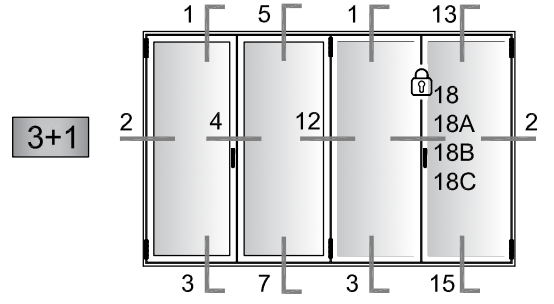

18B

DETAYI
DETAIL

▼ İÇ
(INSIDE)

DEAYLAR DETAILS

REFD77

KATLANIR KAPI İÇE AÇILIM DETAYI
FOLDING DOOR INWARD OPENING DETAIL

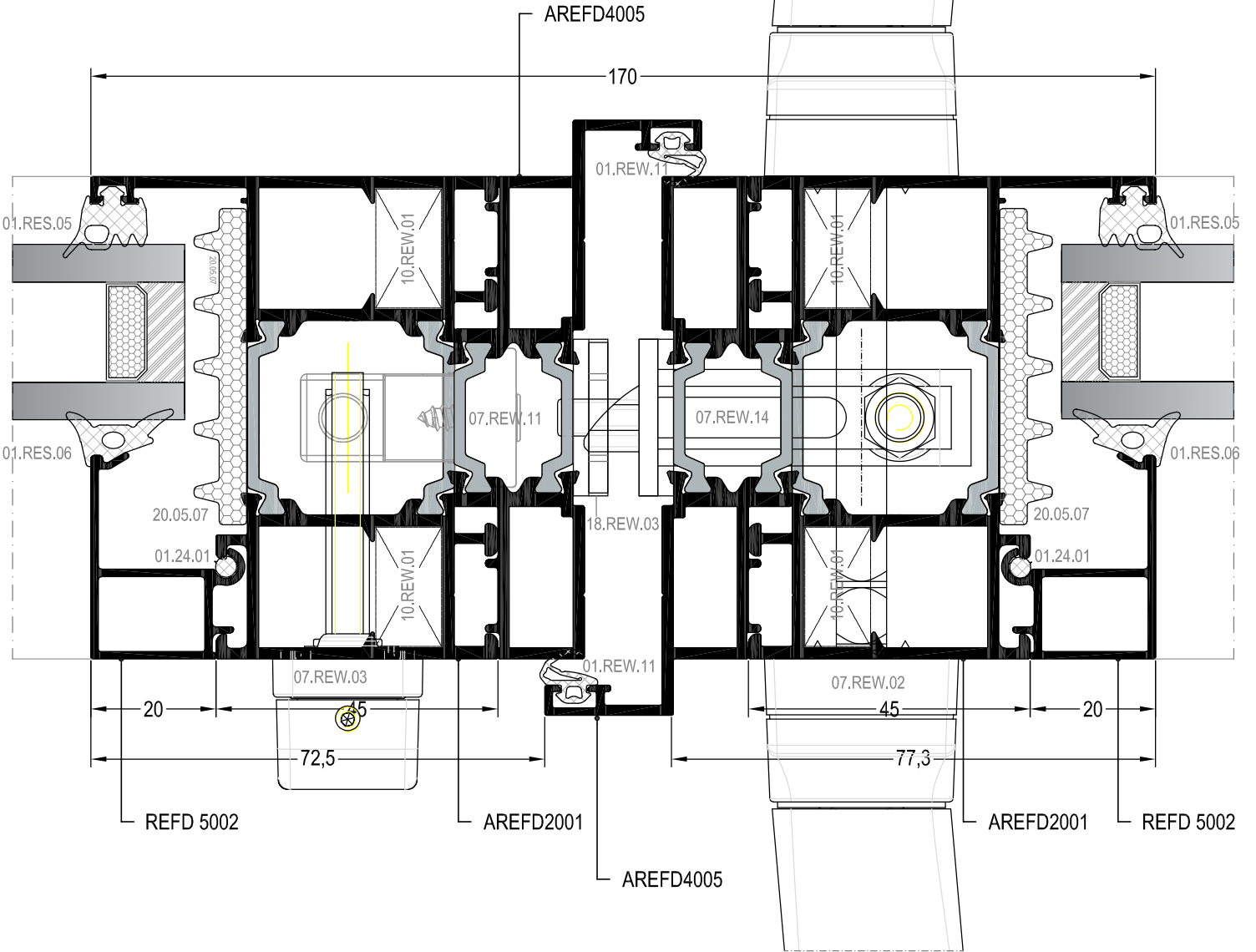
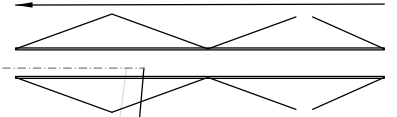
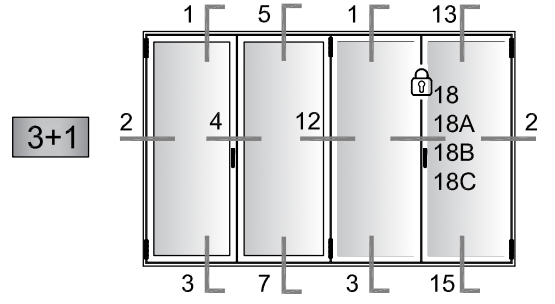

18C

DETAYI
DETAIL

▼ İÇ
(INSIDE)

DETAYLAR DETAILS

REFD77

KATLANIR KAPI İÇE AÇILIM DETAYI
FOLDING DOOR INWARD OPENING DETAIL

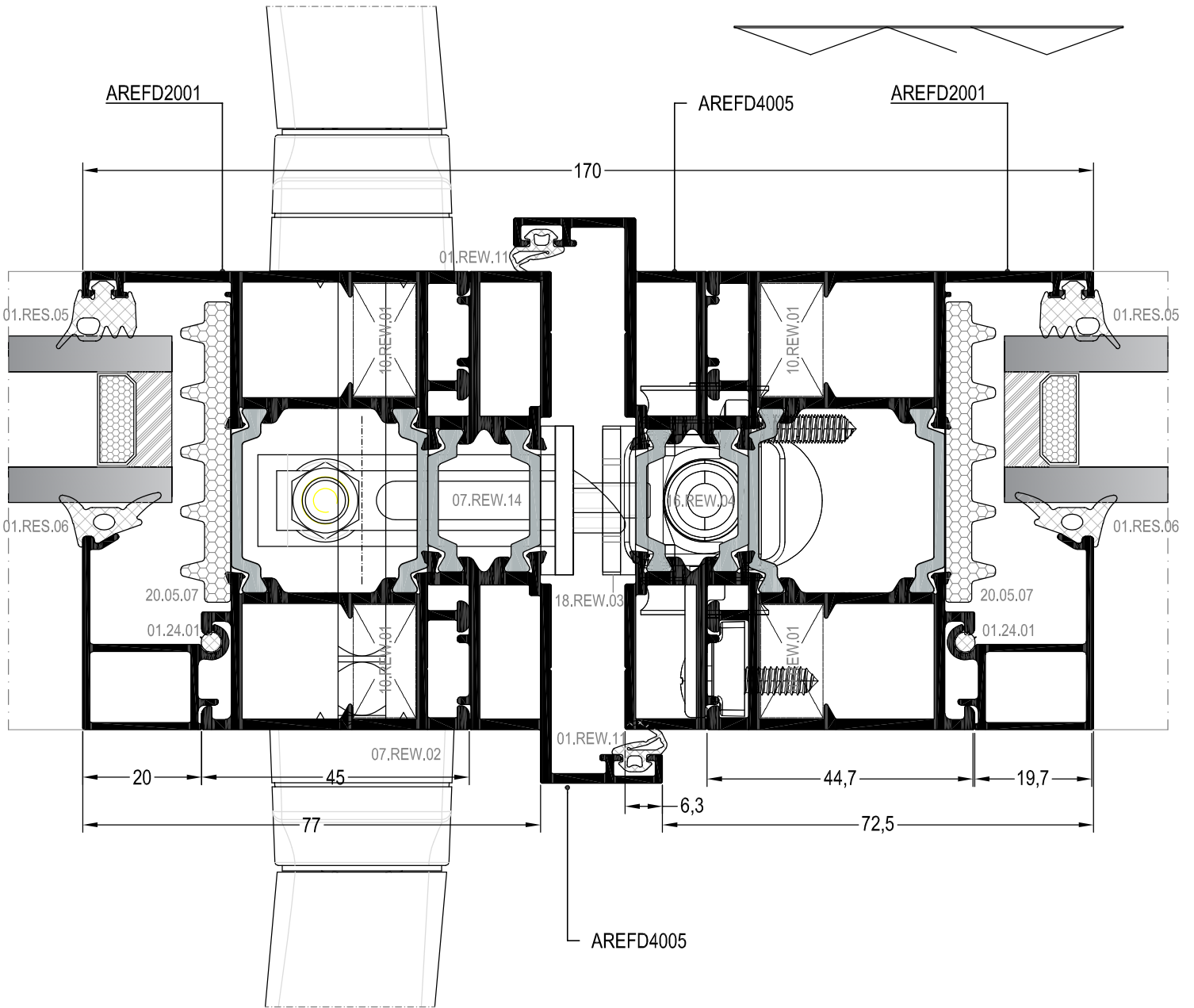
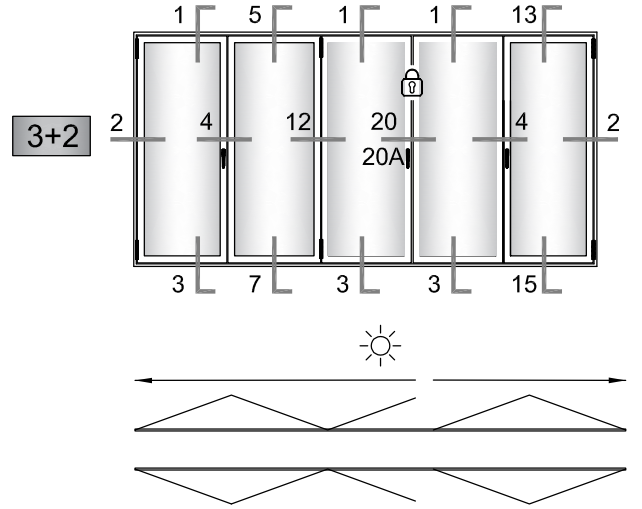

20A

DETAYI
DETAIL

▼ İÇ
(INSIDE)

DETAYLAR DETAILS

REFD77

KATLANIR KAPI DIŐA AÇILIM DETAYI
FOLDING DOOR OUTWARD OPENING DETAIL

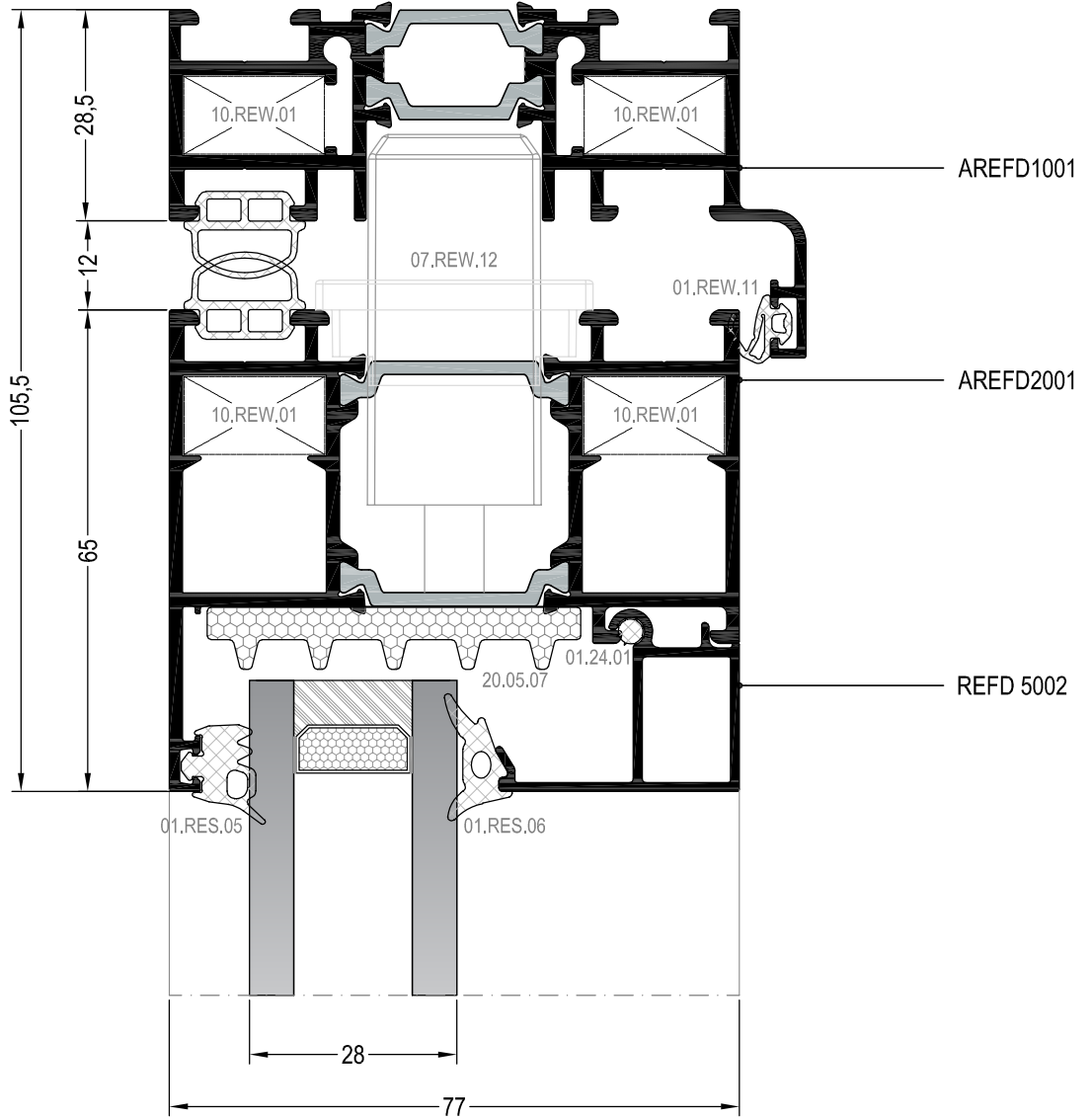
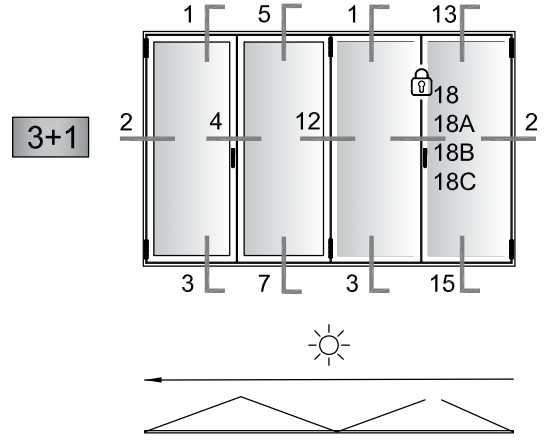

① DETAYI
DETAIL

İÇ
(INSIDE) ➔

DETAYLAR DETAILS

REFD77

KATLANIR KAPI DIŐA AÇILIM DETAYI
FOLDING DOOR OUTWARD OPENING DETAIL

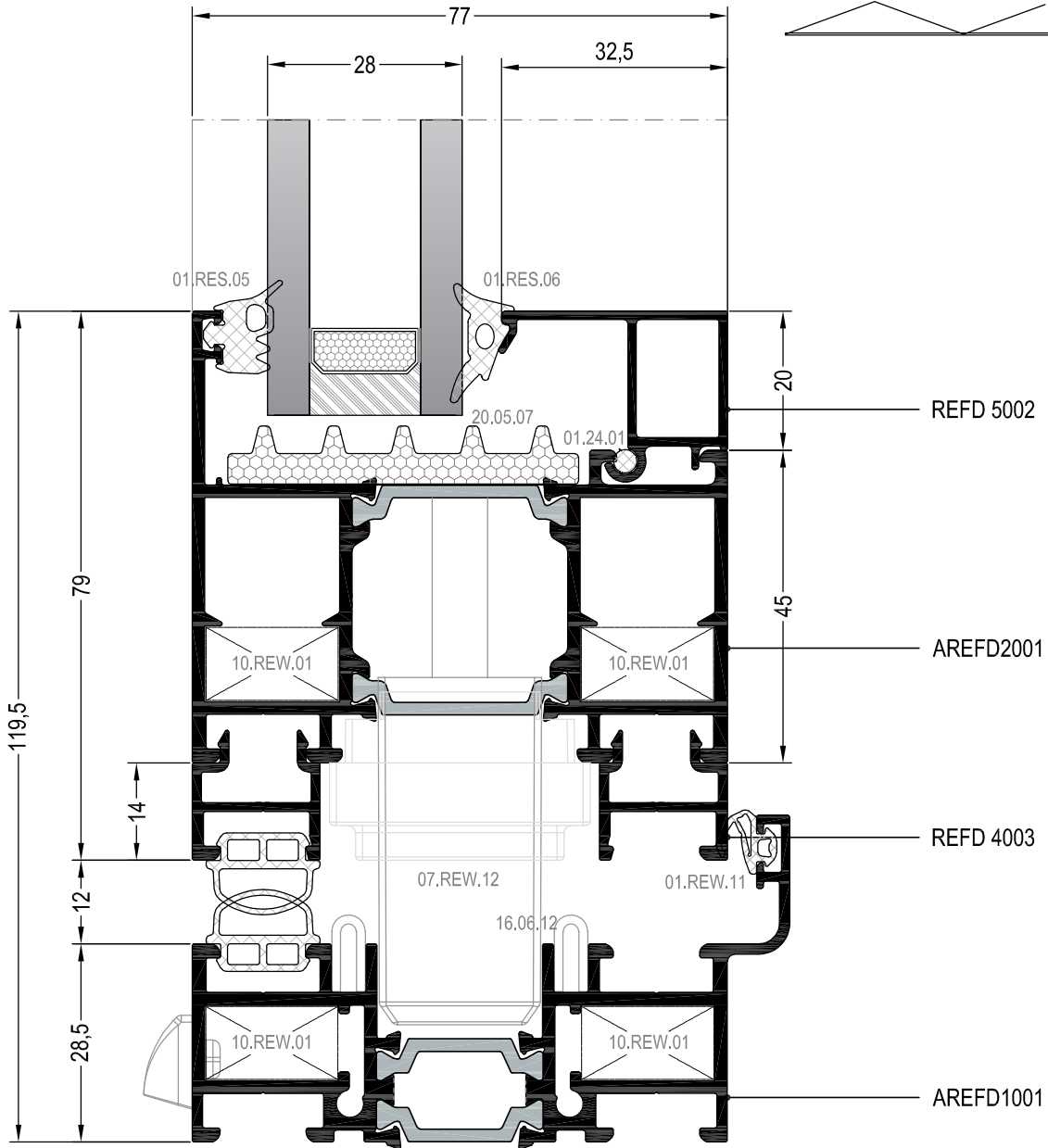
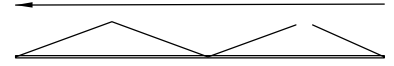
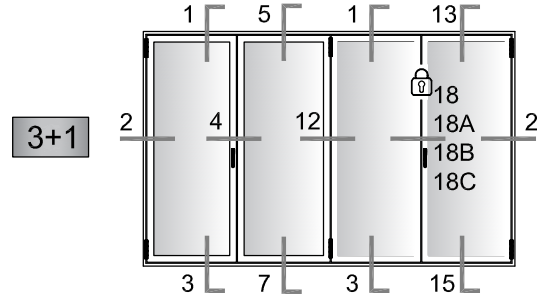

③ DETAYI
DETAIL

İÇ
(INSIDE) ➔

DETAYLAR DETAILS

REFD77

KATLANIR KAPI DIŐA AÇILIM ALTERNATİF KASA DETAYI
FOLDING DOOR OUTWARD OPENING ALTERNATIVE FRAME DETAIL

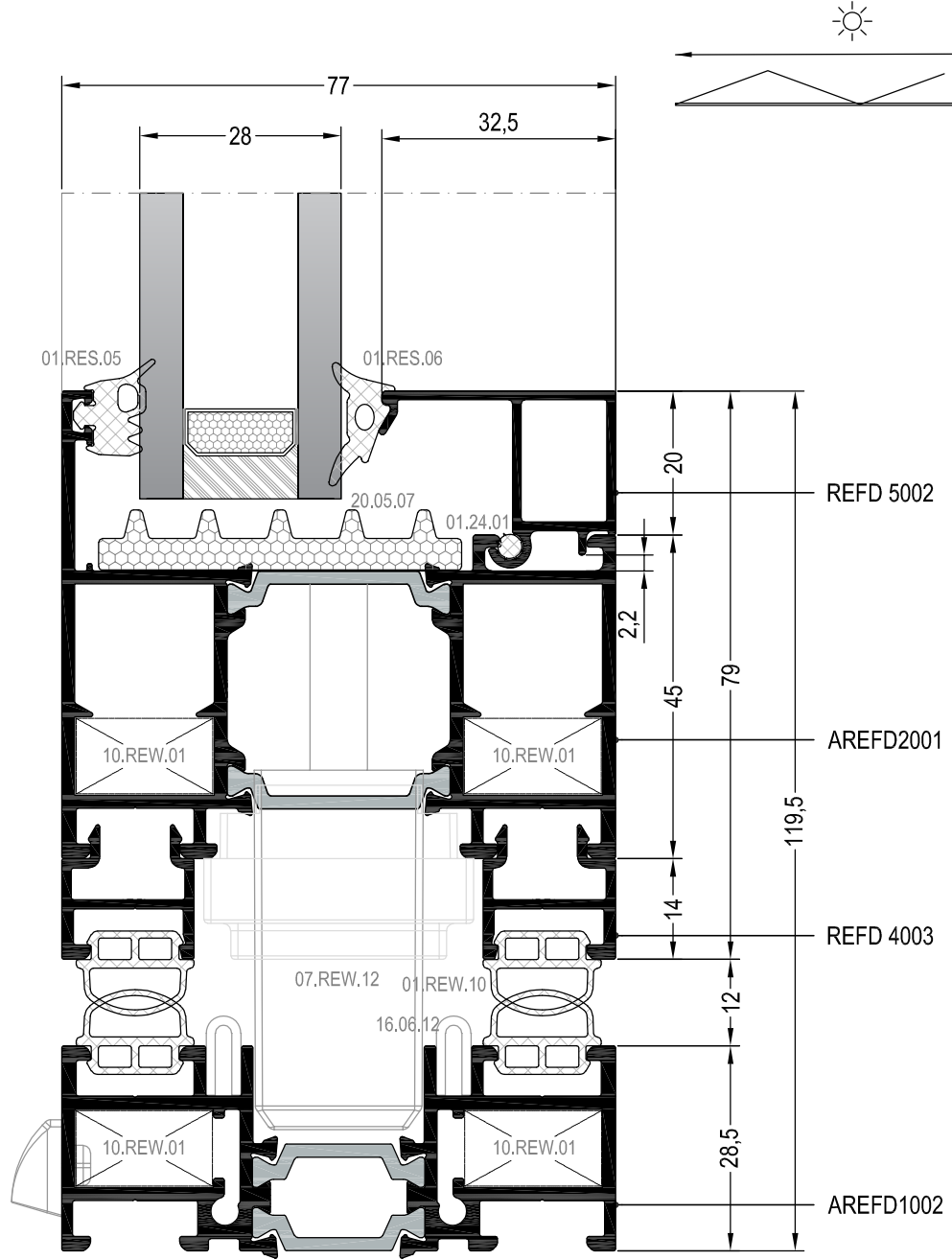
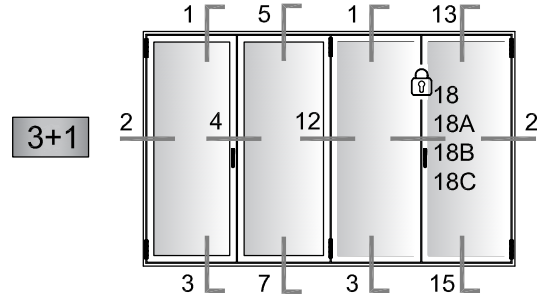

İÇ
(INSIDE) ➔

3A DETAYI
DETAIL

DETAYLAR DETAILS

REFD77

KATLANIR KAPI DIŐA AÇILIM DETAYI
FOLDING DOOR OUTWARD OPENING DETAIL

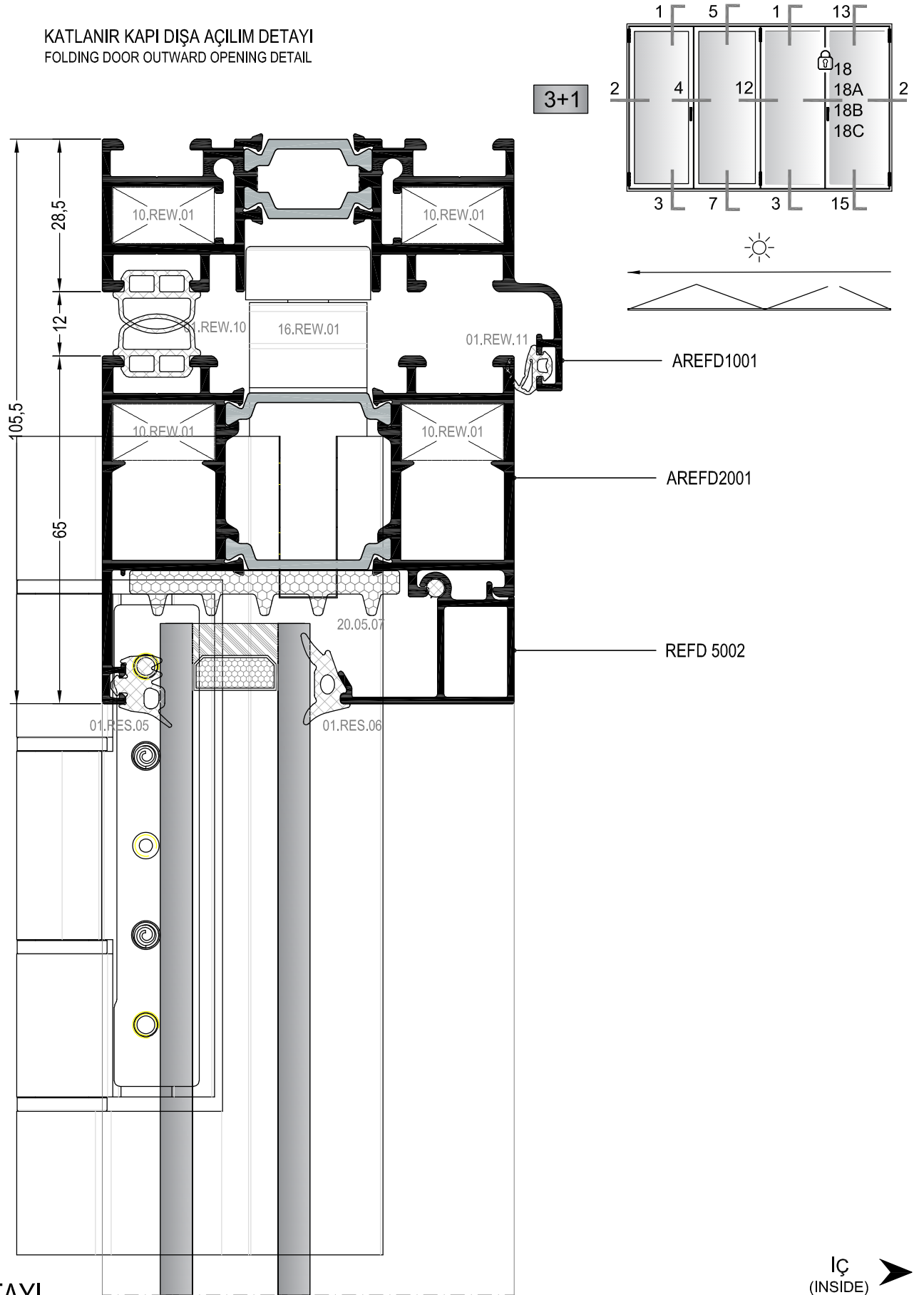

DETAYLAR DETAILS

REFD77

KATLANIR KAPI DIŐA AÇILIM DETAYI
FOLDING DOOR OUTWARD OPENING DETAIL

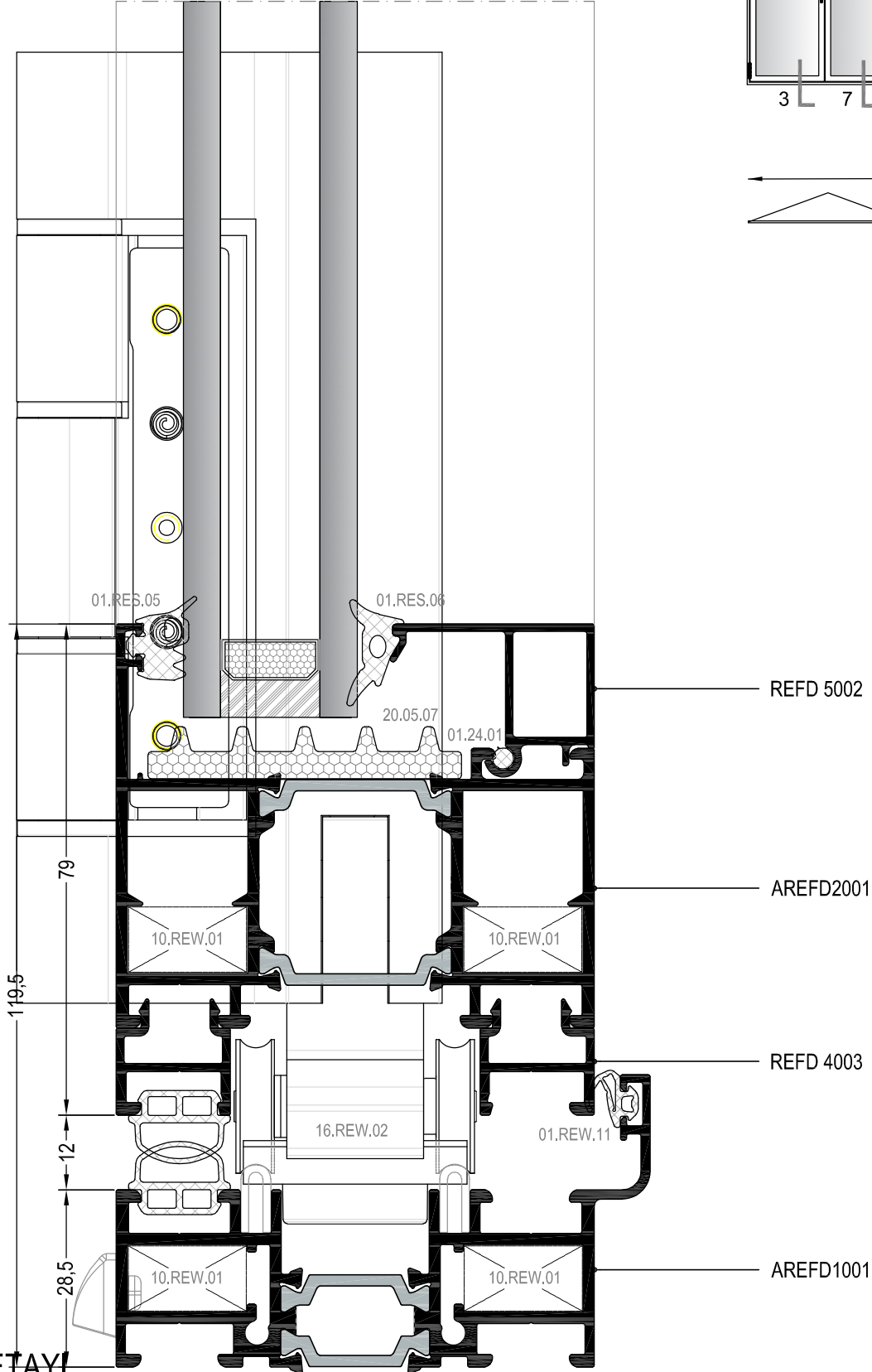

7 DETAYI
DETAIL

İÇ
(INSIDE) ➔

DETAYLAR DETAILS

REFD77

KATLANIR KAPI DIŐA AÇILIM DETAYI
FOLDING DOOR OUTWARD OPENING DETAIL

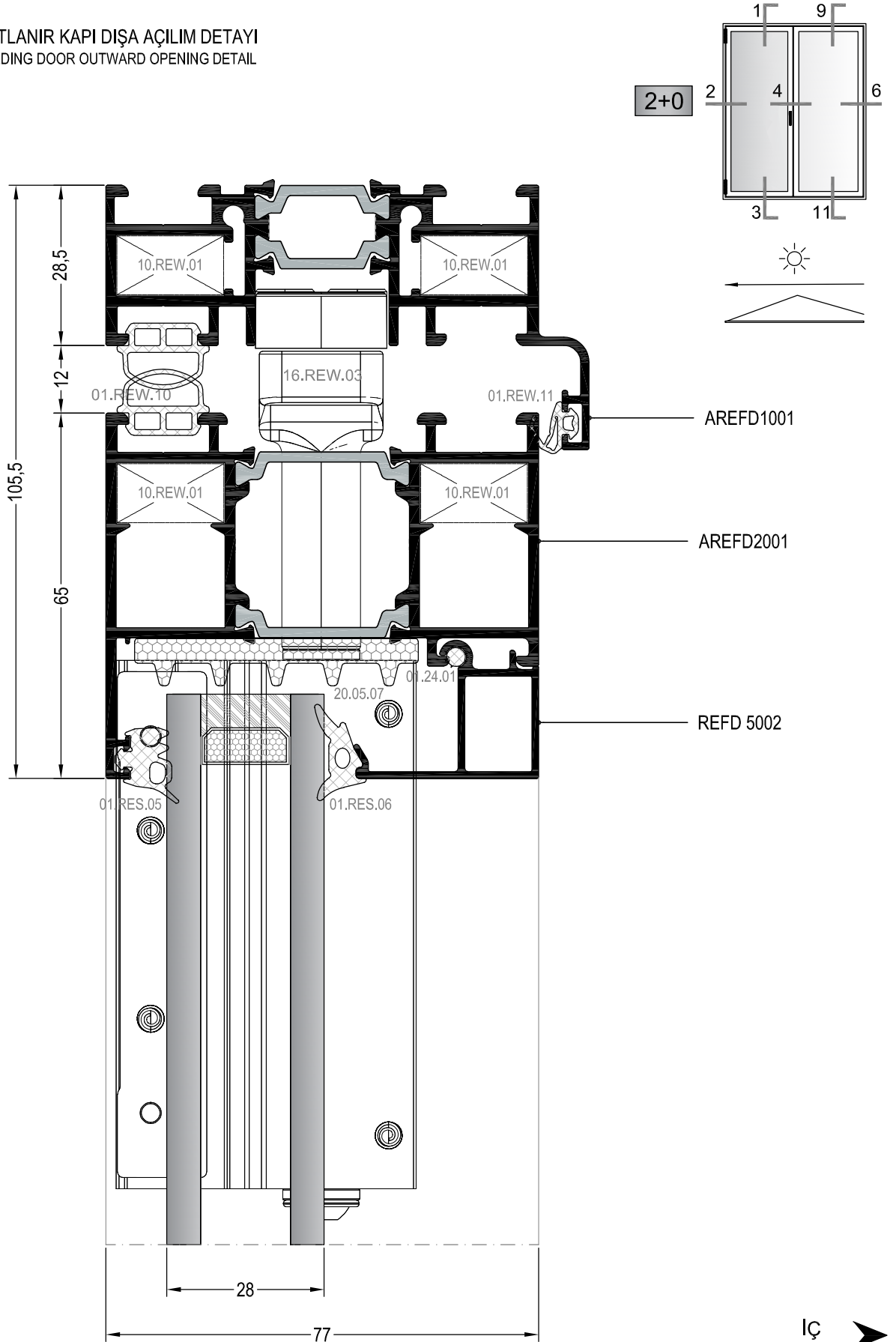

9 DETAYI
DETAIL

DEAYLAR DETAILS

REFD77

KATLANIR KAPI DIŐA AÇILIM DETAYI
FOLDING DOOR OUTWARD OPENING DETAIL

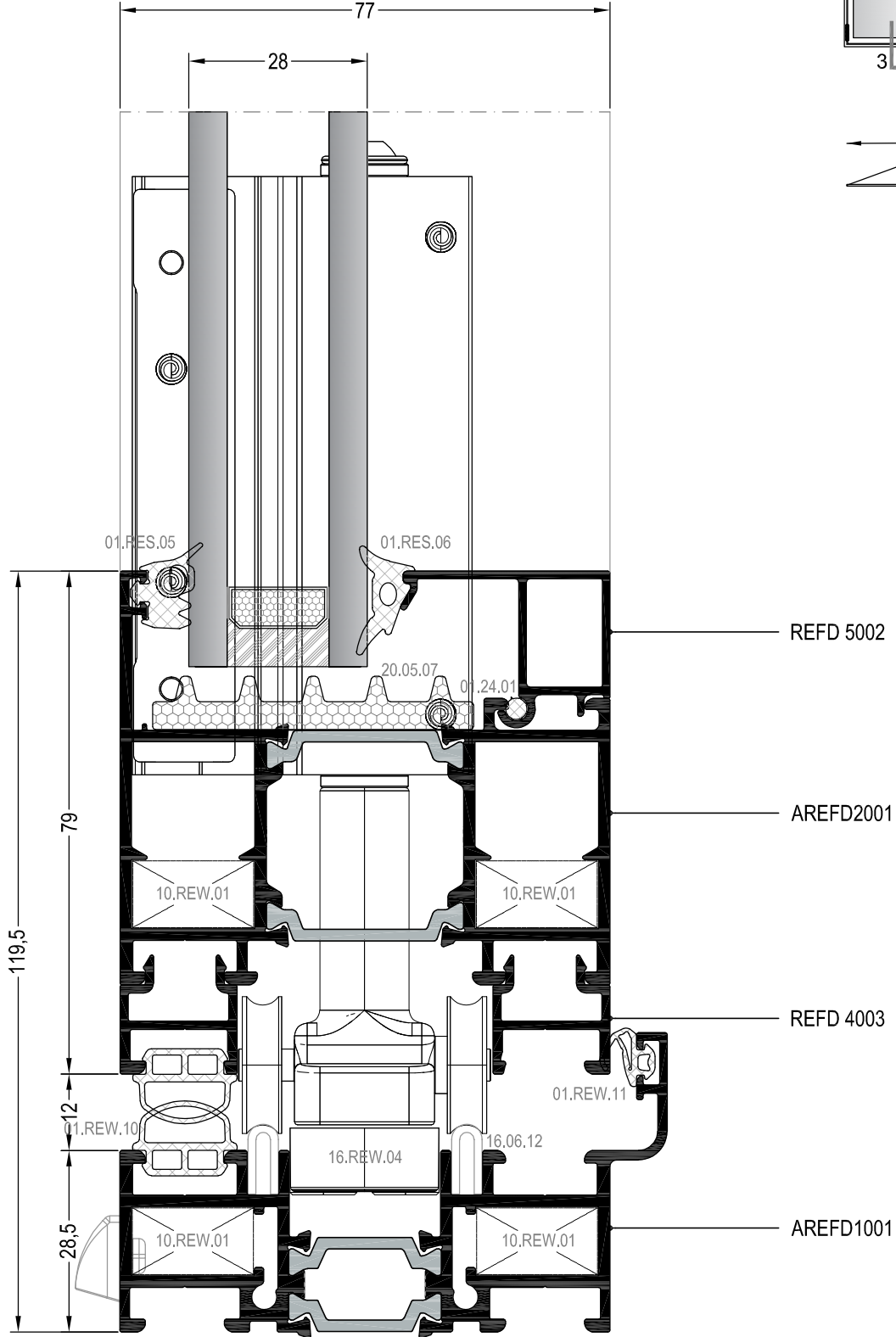
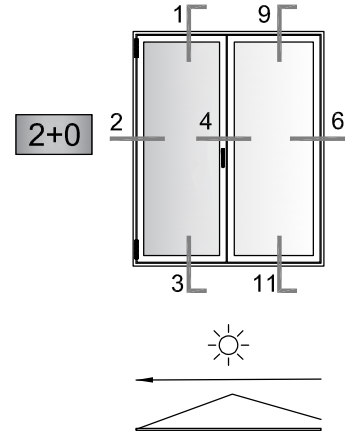

İÇ
(INSIDE) ➔

11 DETAYI
DETAIL

DETAYLAR DETAILS

REFD77

KATLANIR KAPI DIŐA AÇILIM DETAYI
FOLDING DOOR OUTWARD OPENING DETAIL

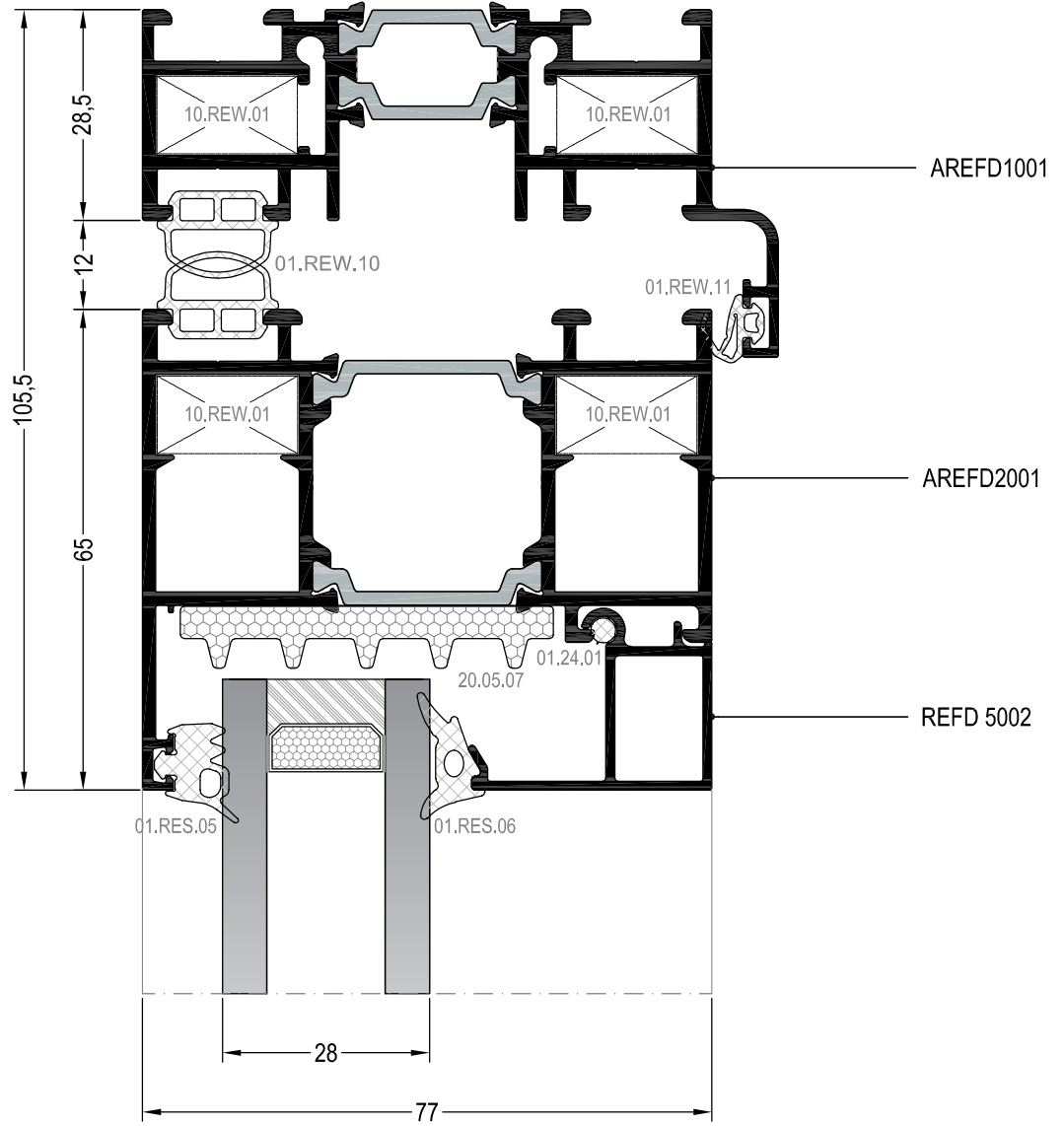
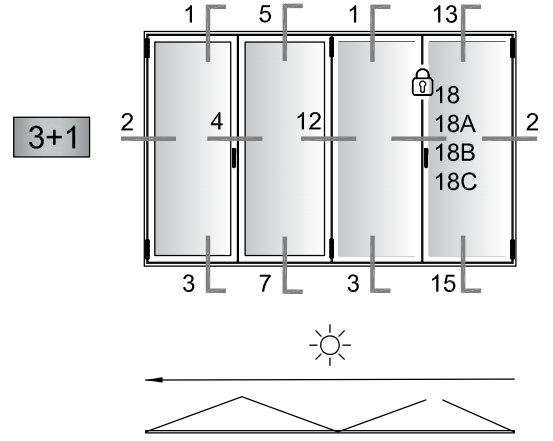

13 DETAYI
DETAIL

İÇ
(INSIDE) ➔

DEAYLAR DETAILS

REFD77

KATLANIR KAPI DIŐA AÇILIM DETAYI
FOLDING DOOR OUTWARD OPENING DETAIL

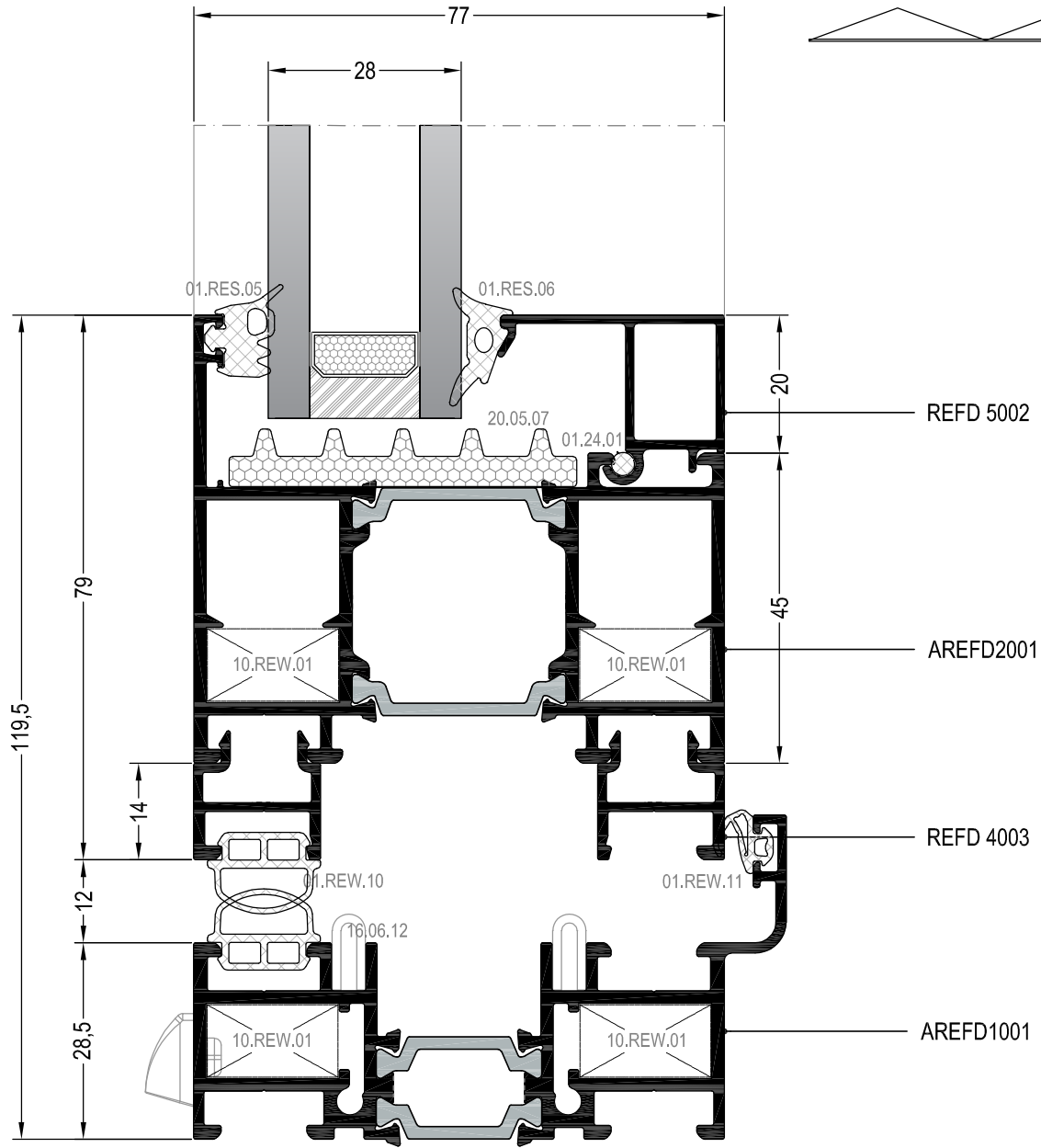
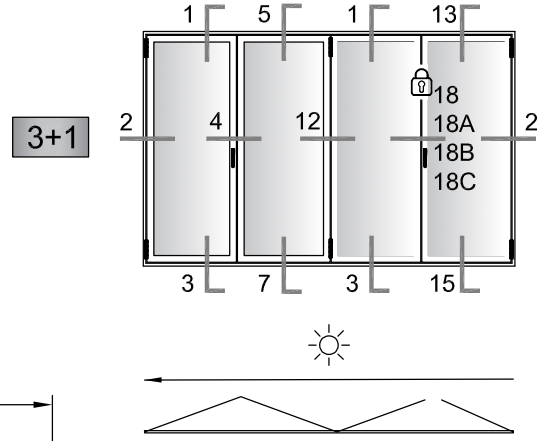

15 DETAYI
DETAIL

İÇ
(INSIDE) ➔

DETAYLAR DETAILS

REFD77

KATLANIR KAPI DIŐA AÇILIM DETAYI
FOLDING DOOR OUTWARD OPENING DETAIL

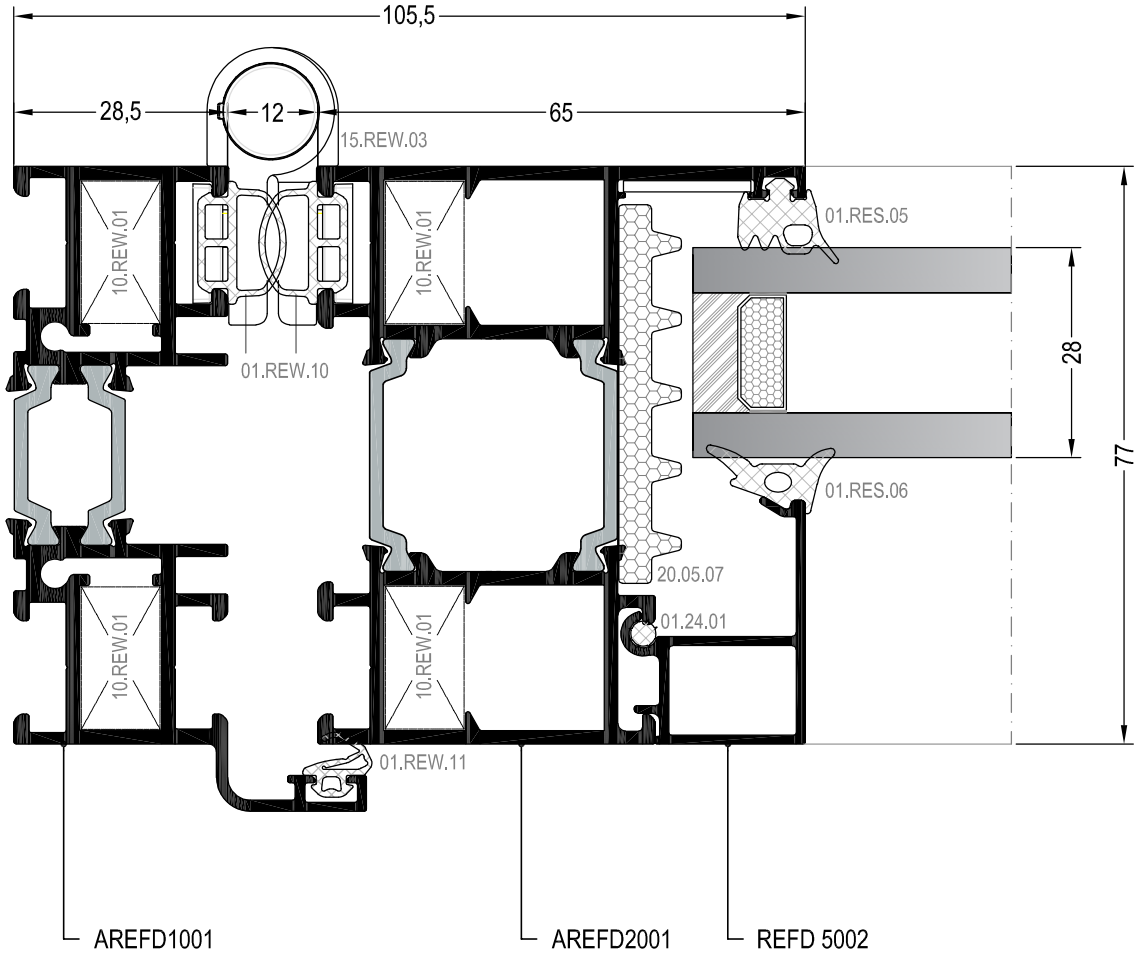
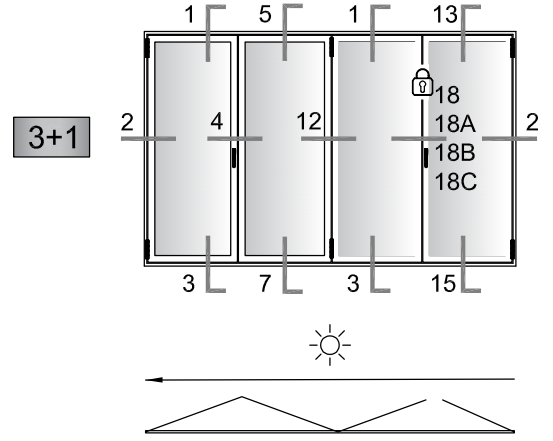

② DETAYI
DETAIL

▼ İÇ
(INSIDE)

DEAYLAR DETAILS

REFD77

KATLANIR KAPI DIŐA AÇILIM DETAYI
FOLDING DOOR OUTWARD OPENING DETAIL

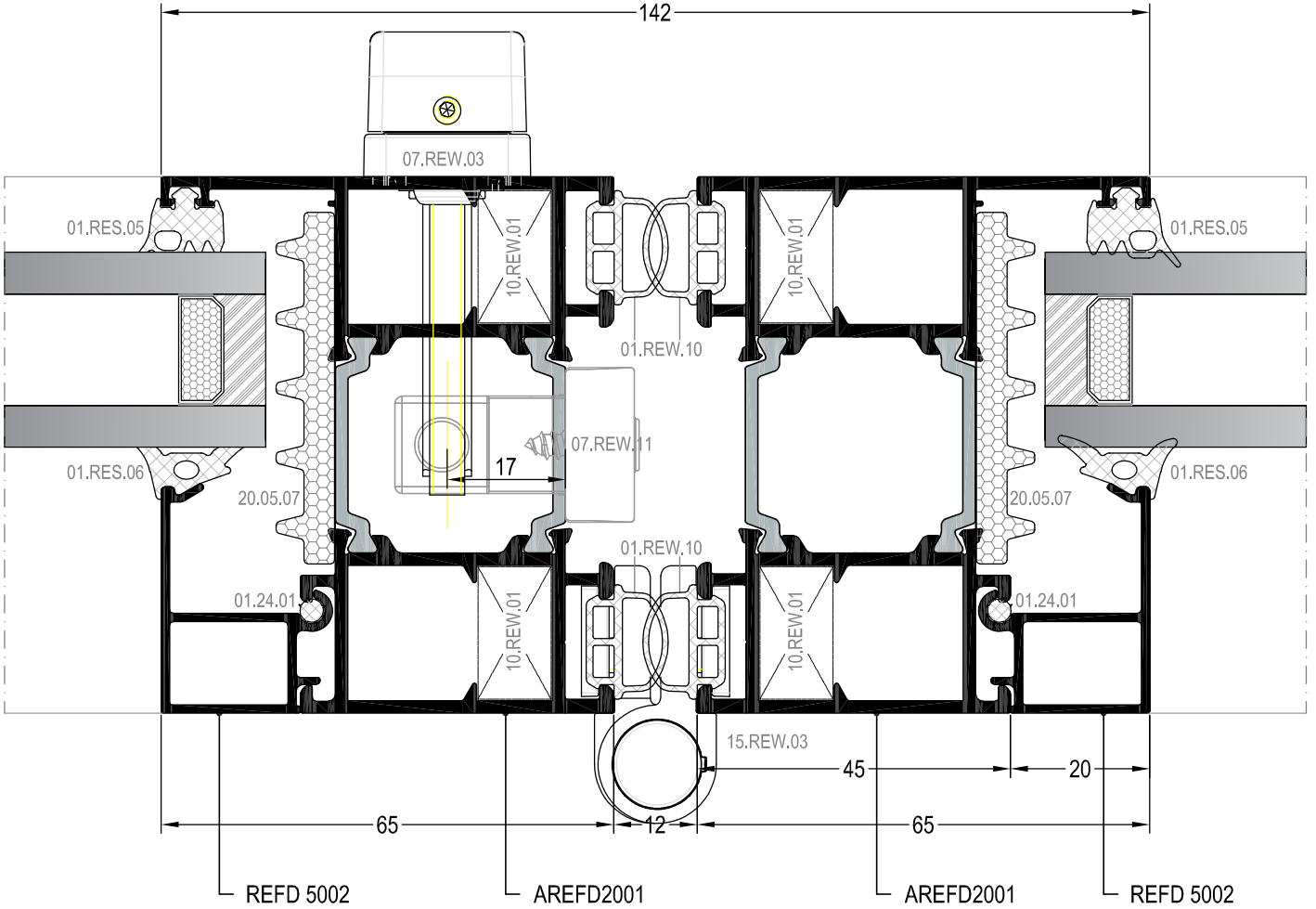
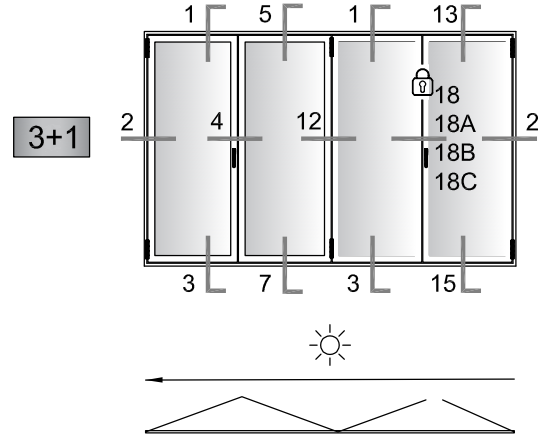

4 DETAYI
DETAIL

İÇ
(INSIDE)

DETAYLAR DETAILS

REFD77

KATLANIR KAPI DIŐA AÇILIM DETAYI
FOLDING DOOR OUTWARD OPENING DETAIL

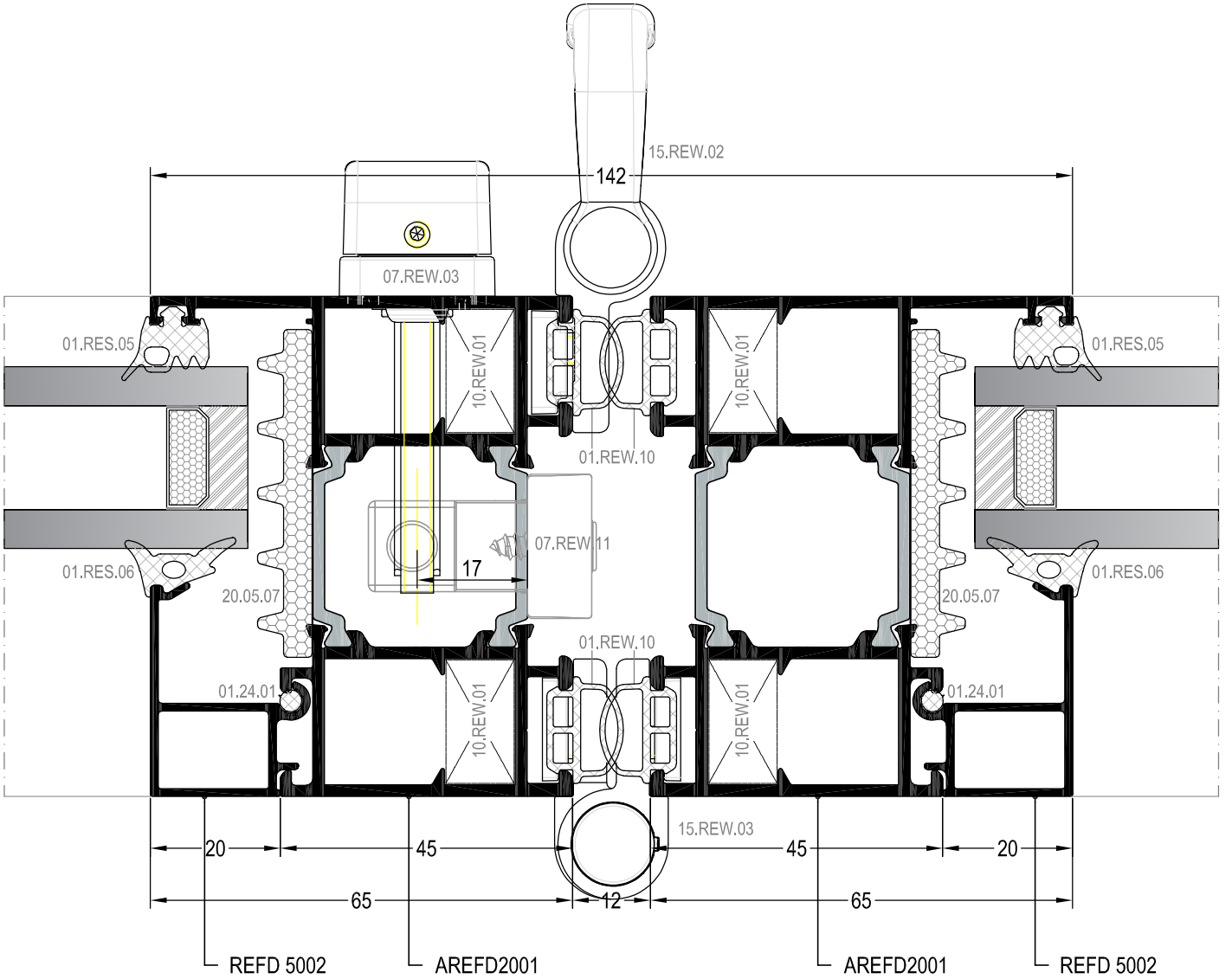
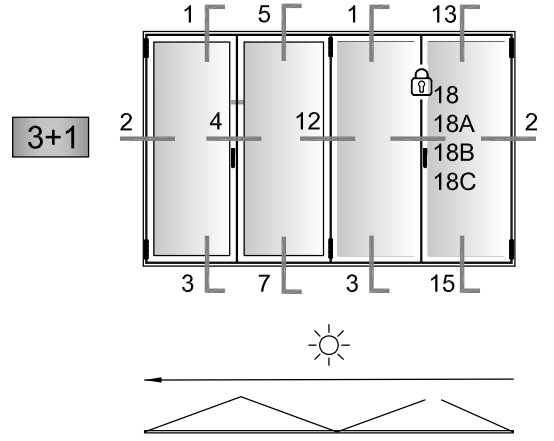

4.1 DETAYI
DETAIL

▼ İÇ
(INSIDE)

DETAYLAR DETAILS

REFD77

KATLANIR KAPI DIŐA AÇILIM DETAYI
FOLDING DOOR OUTWARD OPENING DETAIL

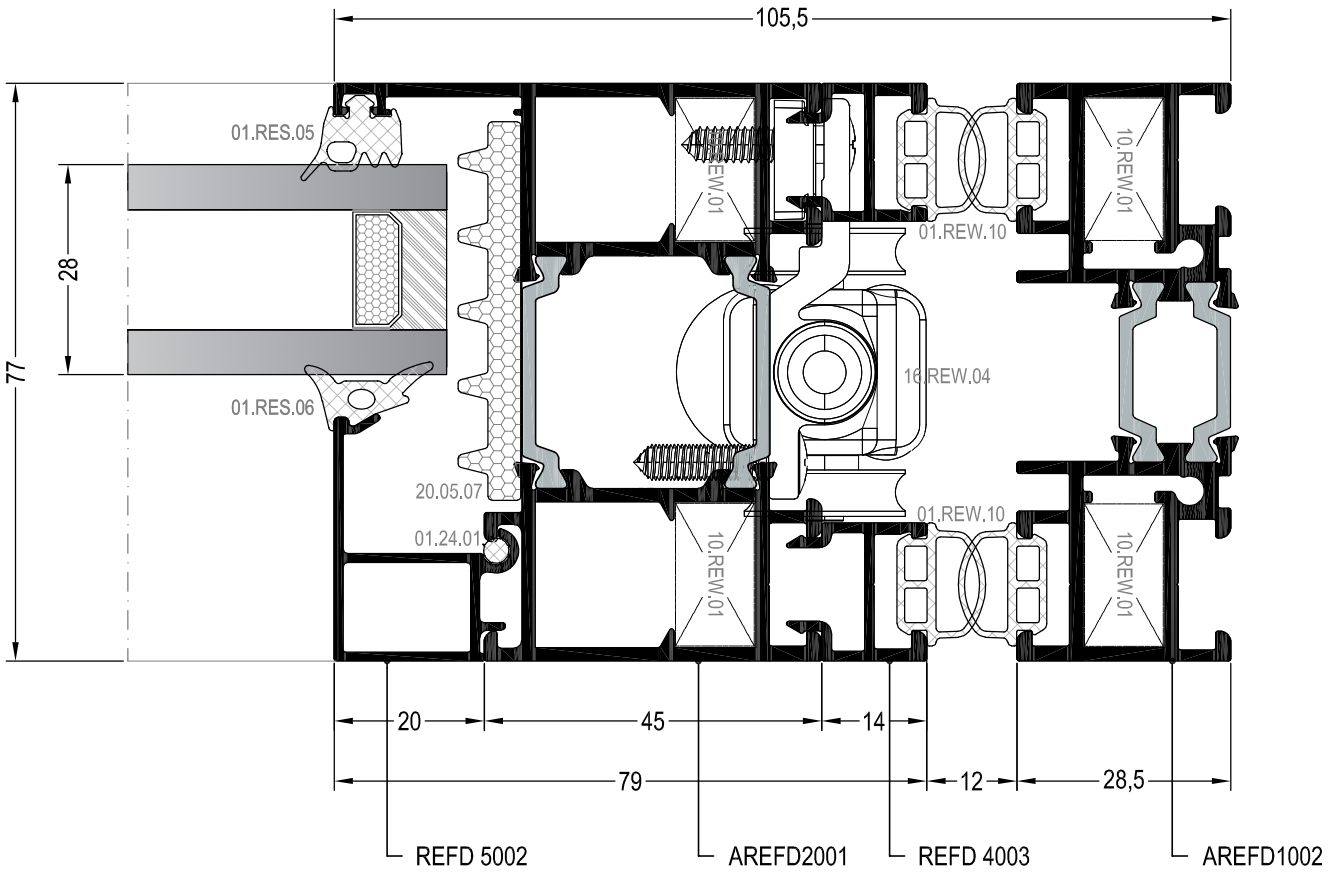
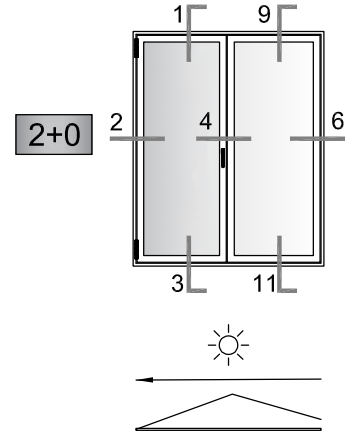

⑥ DETAYI
DETAIL

▼ İÇ
(INSIDE)

DEAYLAR DETAILS

REFD77

KATLANIR KAPI DIŐA AÇILIM DETAYI
FOLDING DOOR OUTWARD OPENING DETAIL

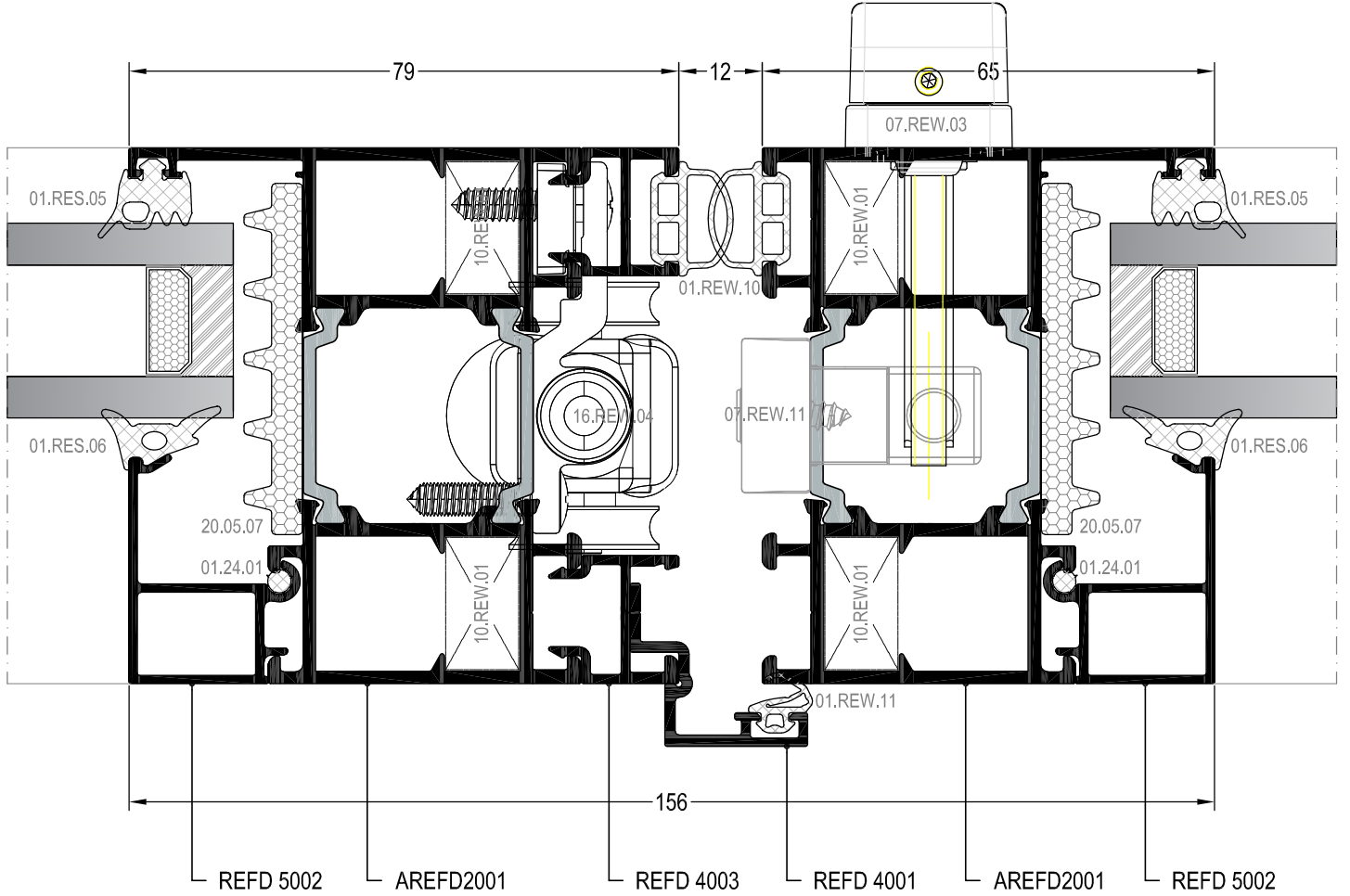
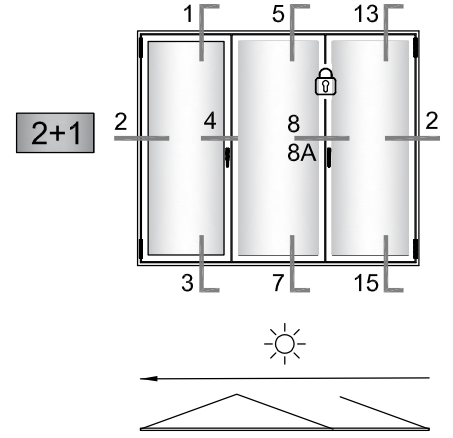

8 DETAYI
DETAIL

▼ İÇ
(INSIDE)

DEAYLAR DETAILS

REFD77

KATLANIR KAPI DIŐA AÇILIM DETAYI
FOLDING DOOR OUTWARD OPENING DETAIL

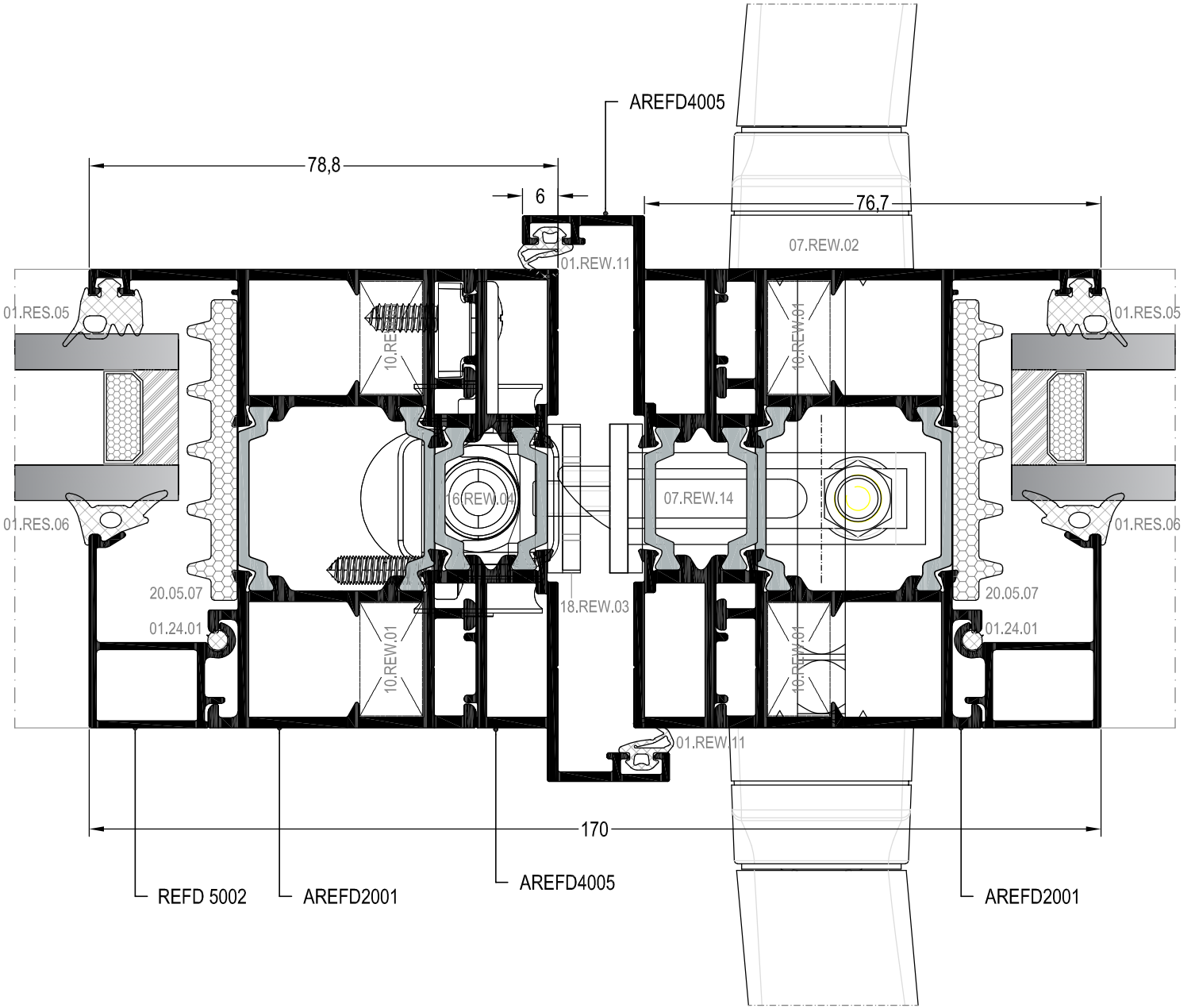
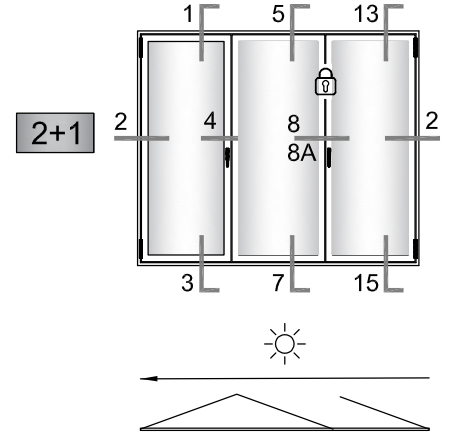

8A DETAYI
DETAIL

▼ İÇ
(INSIDE)

DEAYLAR DETAILS

REFD77

KATLANIR KAPI DIŐA AÇILIM DETAYI
FOLDING DOOR OUTWARD OPENING DETAIL

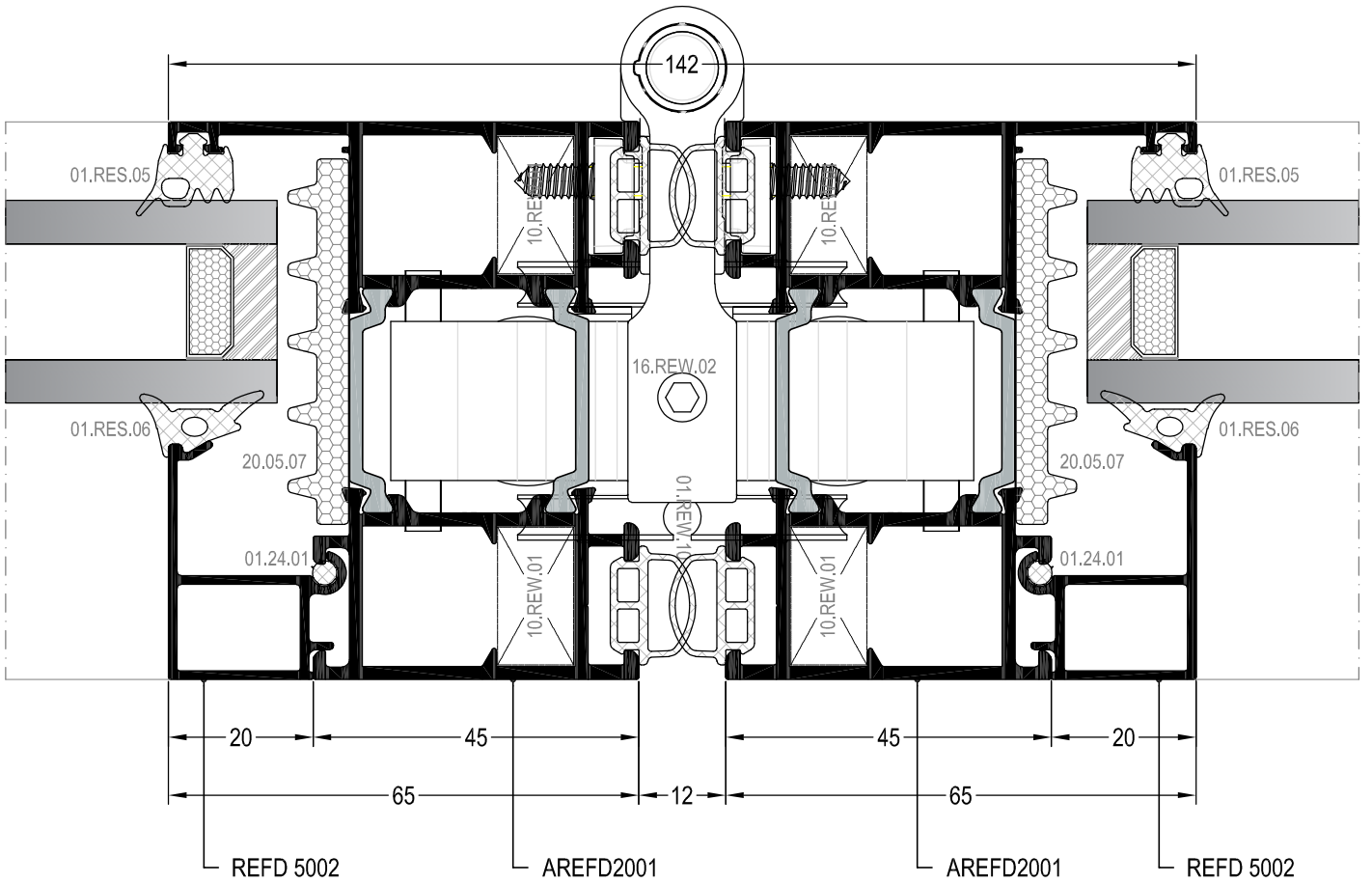
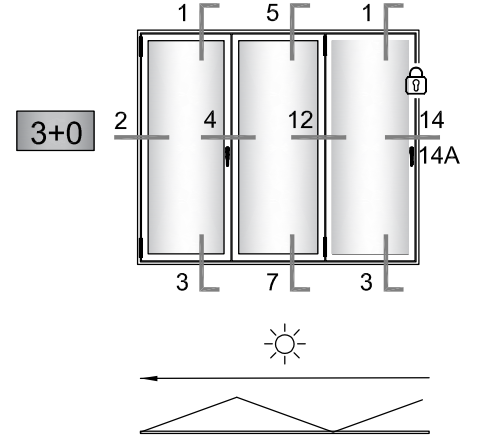

12 DETAYI
DETAIL

▼ İÇ
(INSIDE)

DEAYLAR DETAILS

REFD77

KATLANIR KAPI DIŐA AÇILIM DETAYI
FOLDING DOOR OUTWARD OPENING DETAIL

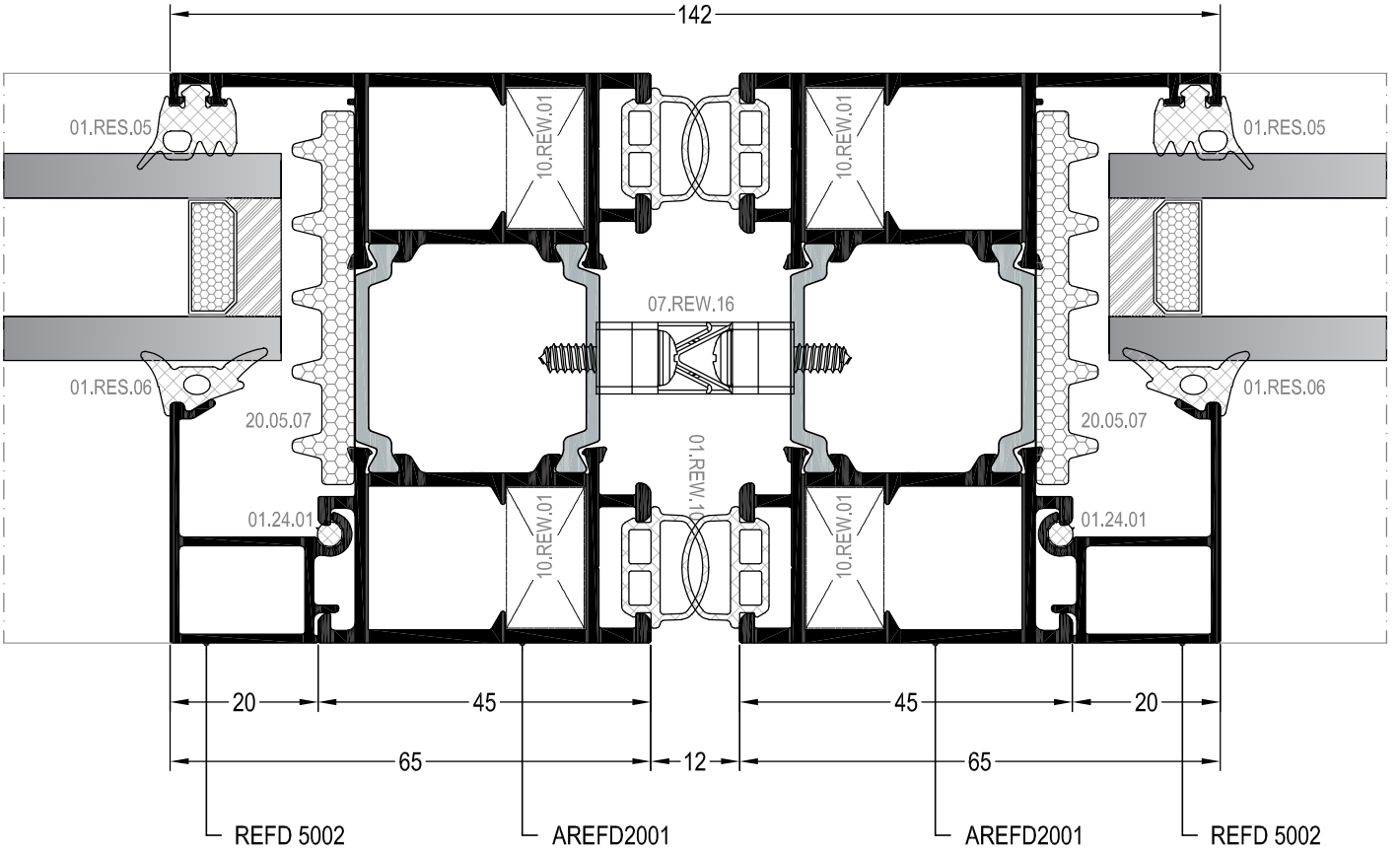
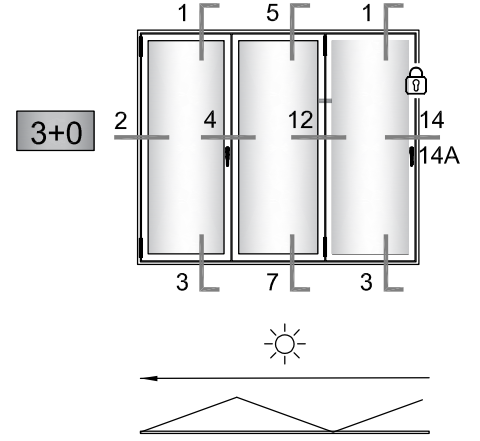

12.1 DETAYI
DETAIL

▼ İÇ
(INSIDE)

DETAYLAR DETAILS

REFD77

KATLANIR KAPI DIŐA AÇILIM DETAYI
FOLDING DOOR OUTWARD OPENING DETAIL

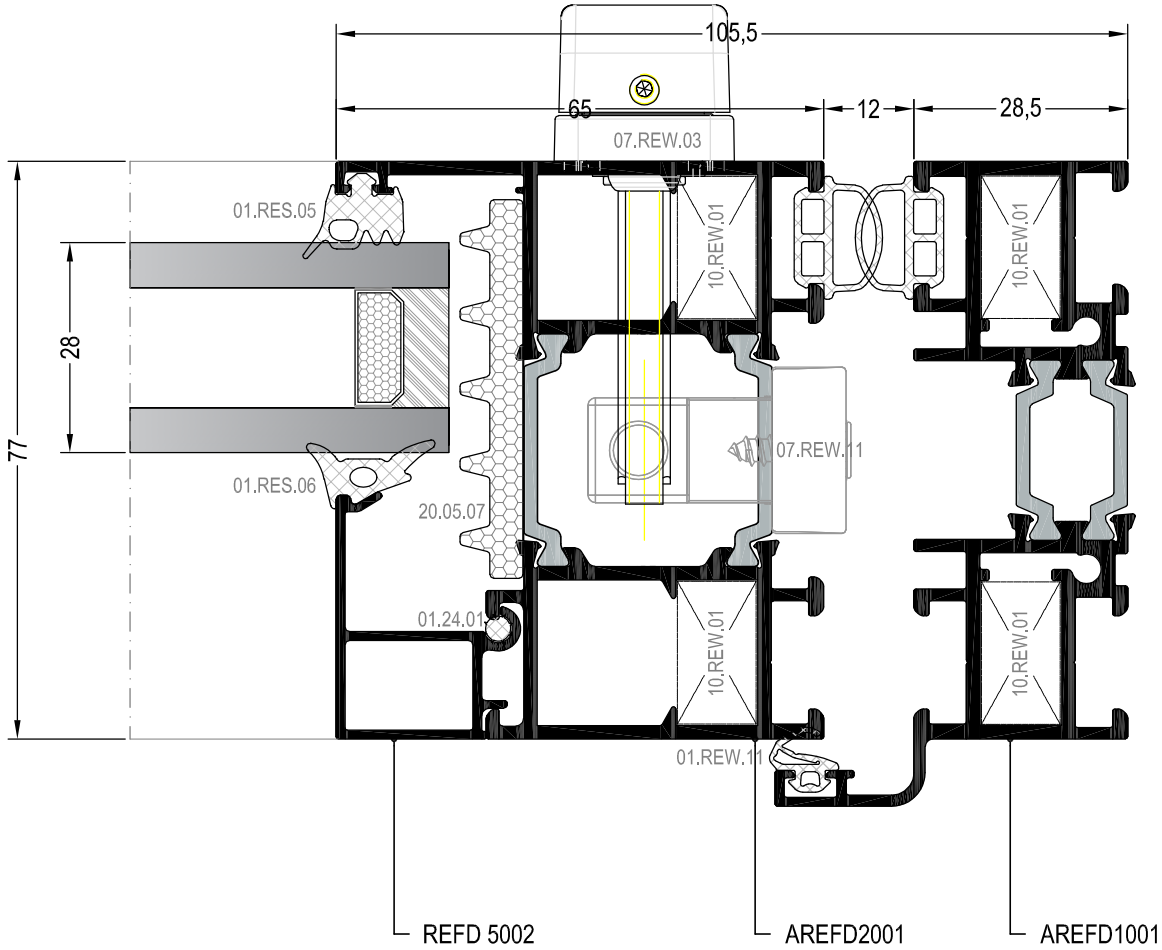
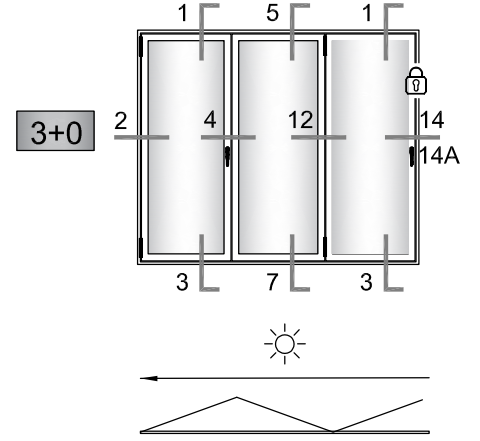

14 DETAYI
DETAIL

▼ İÇ
(INSIDE)

DEAYLAR DETAILS

REFD77

KATLANIR KAPI DİŐA AÇILIM DETAYI
FOLDING DOOR OUTWARD OPENING DETAIL

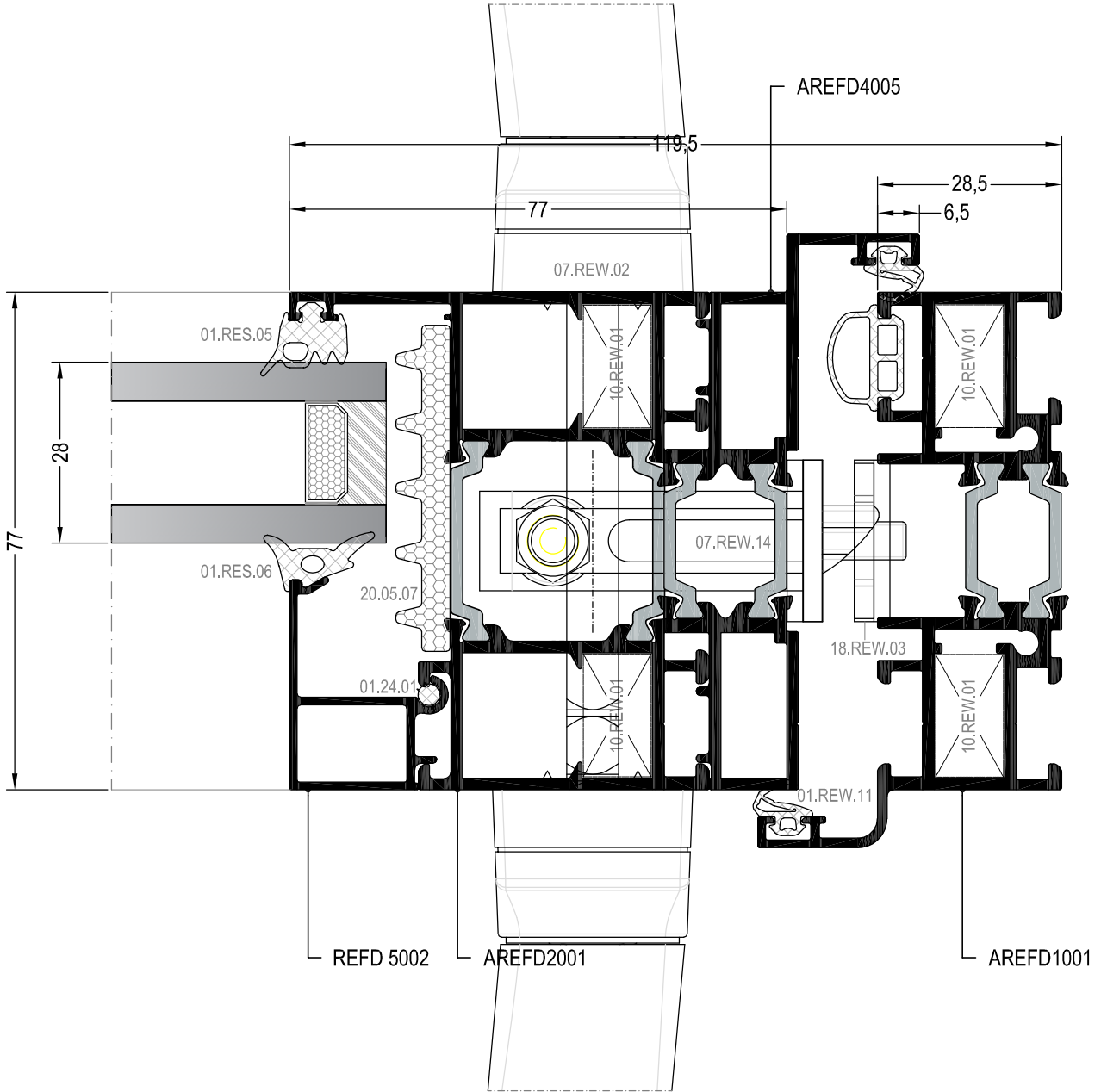
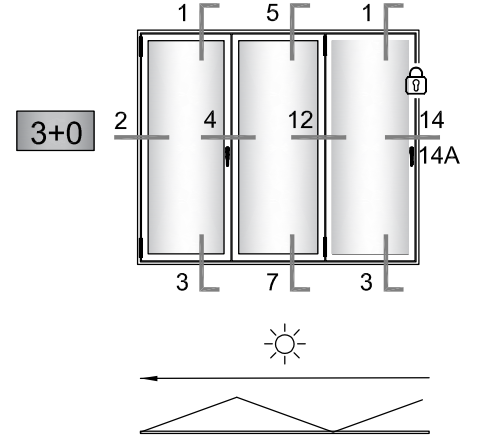

14A

DETAYI
DETAIL

▼ İÇ
(INSIDE)

DEAYLAR DETAILS

REFD77

KATLANIR KAPI DIŐA AÇILIM DETAYI
FOLDING DOOR OUTWARD OPENING DETAIL

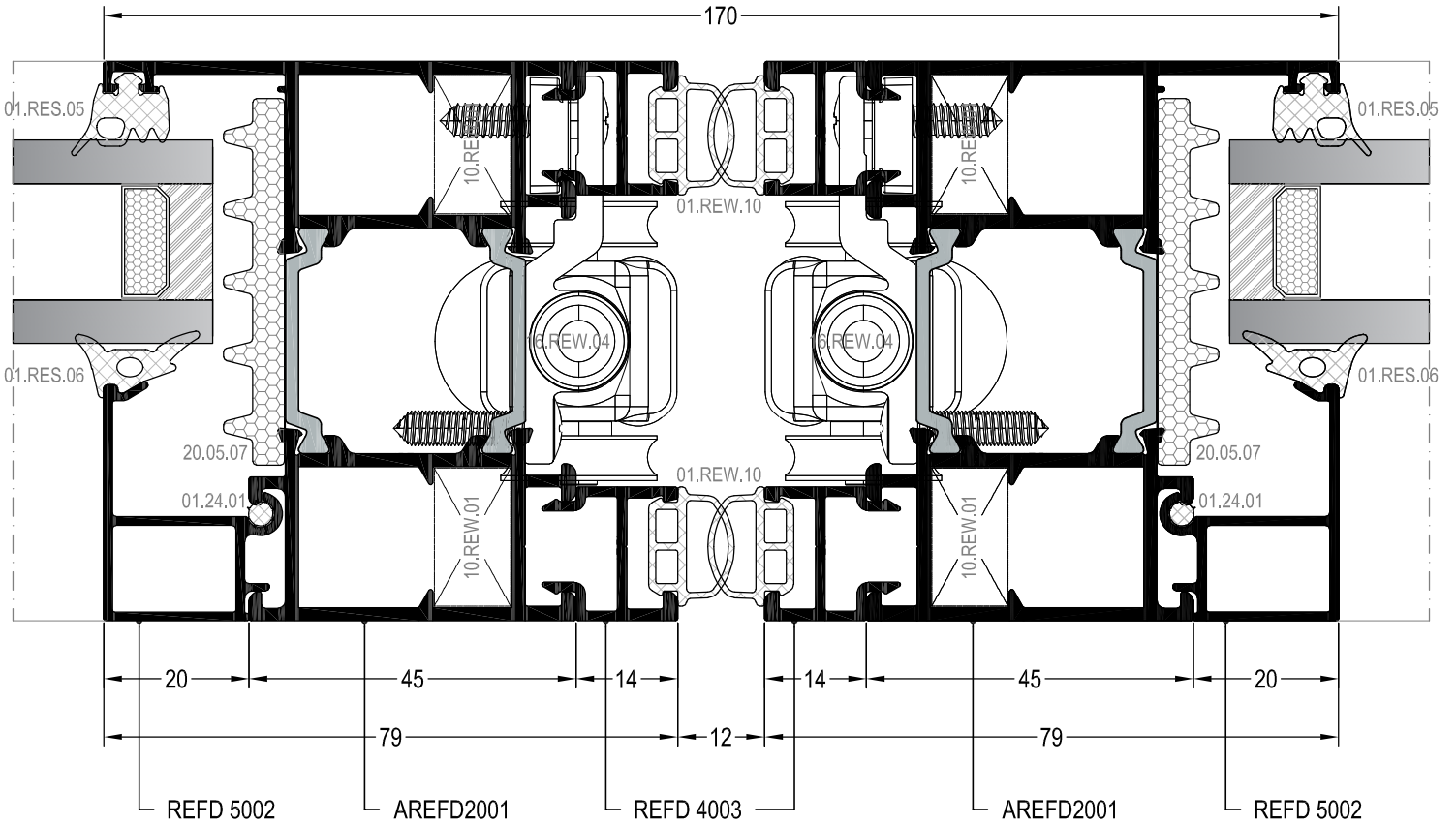
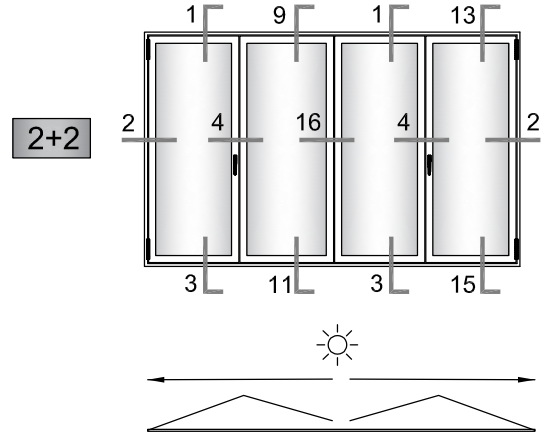

16 DETAYI
DETAIL

İÇ
(INSIDE)

DEAYLAR DETAILS

REFD77

KATLANIR KAPI DİŐA AÇILIM DETAYI
FOLDING DOOR OUTWARD OPENING DETAIL

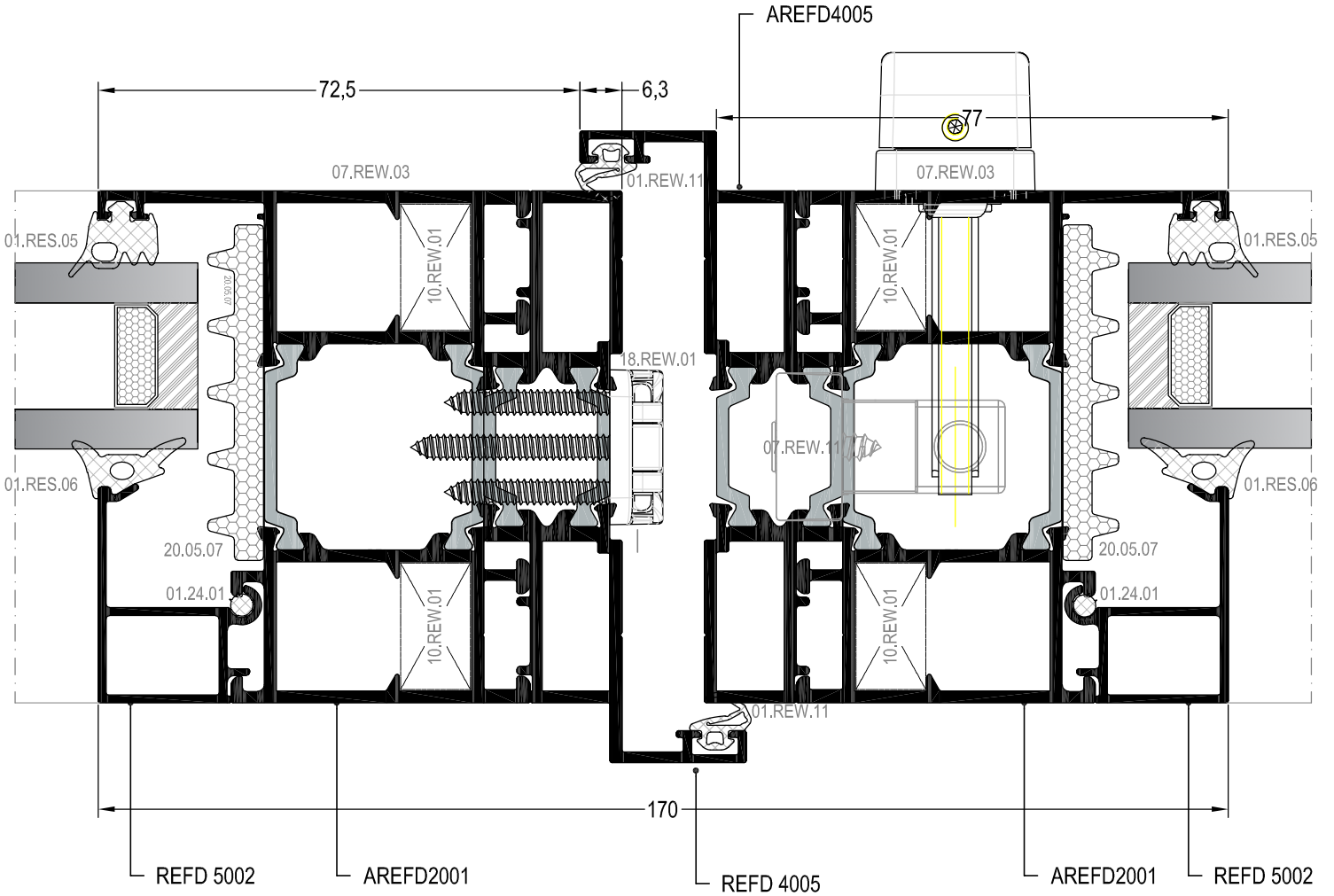
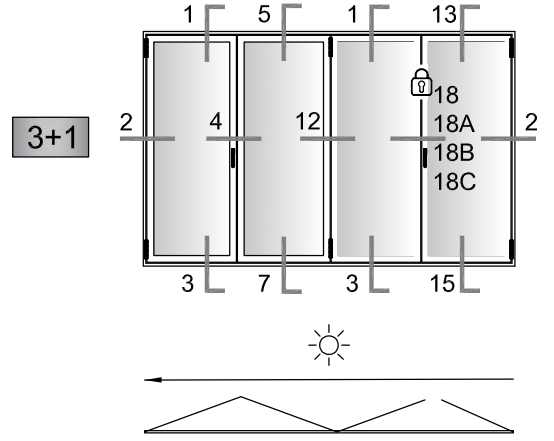

18 DETAYI
DETAIL

▼ İÇ
(INSIDE)

DEAYLAR DETAILS

REFD77

KATLANIR KAPI DİŐA AÇILIM DETAYI
FOLDING DOOR OUTWARD OPENING DETAIL

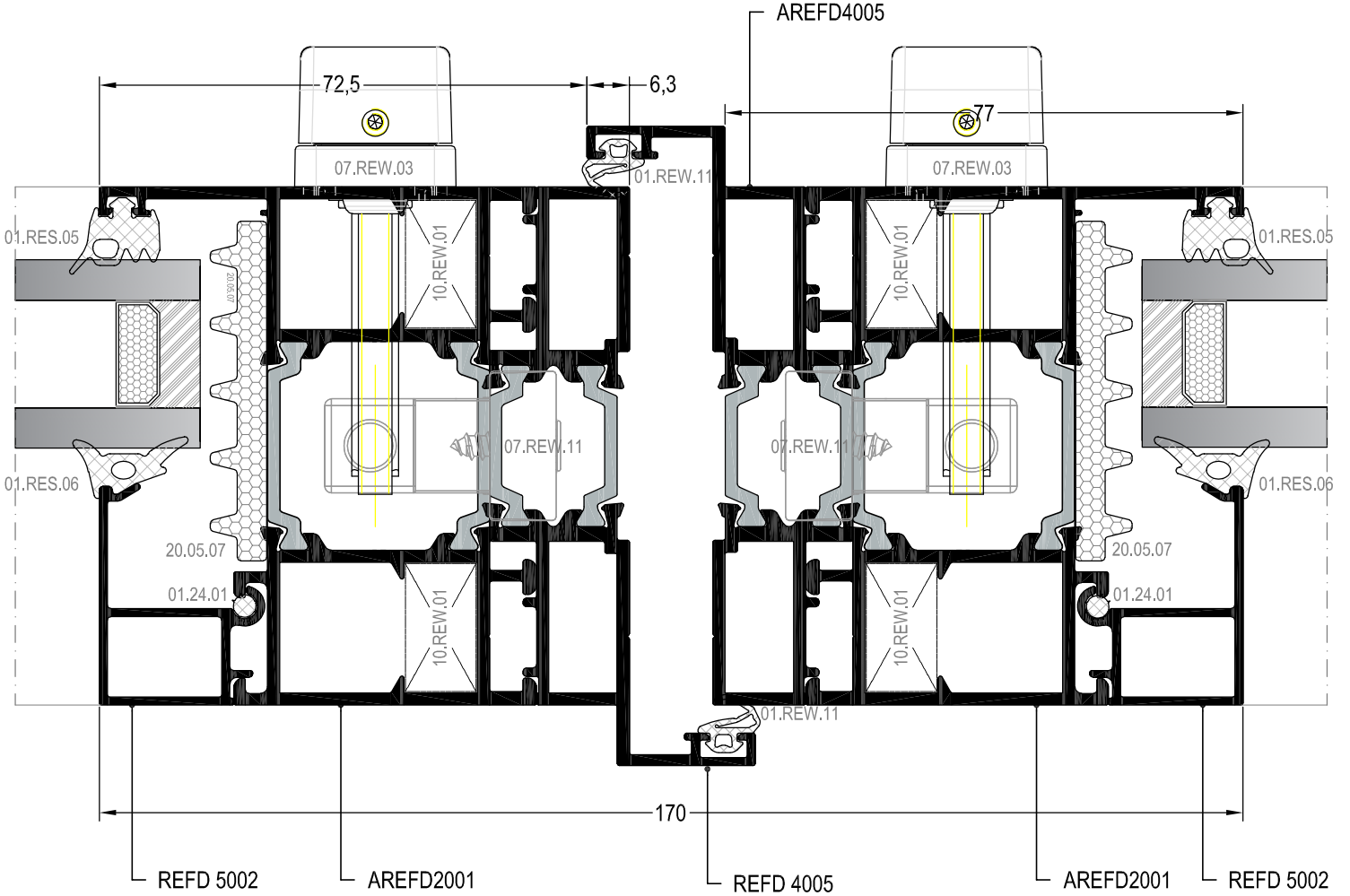
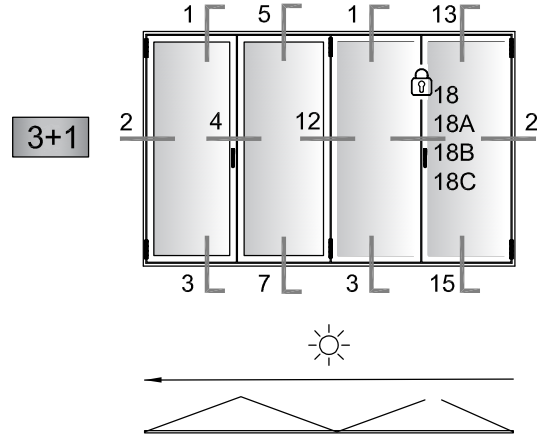

18A DETAYI
DETAIL

İÇ
(INSIDE)

DEAYLAR DETAILS

REFD77

KATLANIR KAPI DIŐA AÇILIM DETAYI
FOLDING DOOR OUTWARD OPENING DETAIL

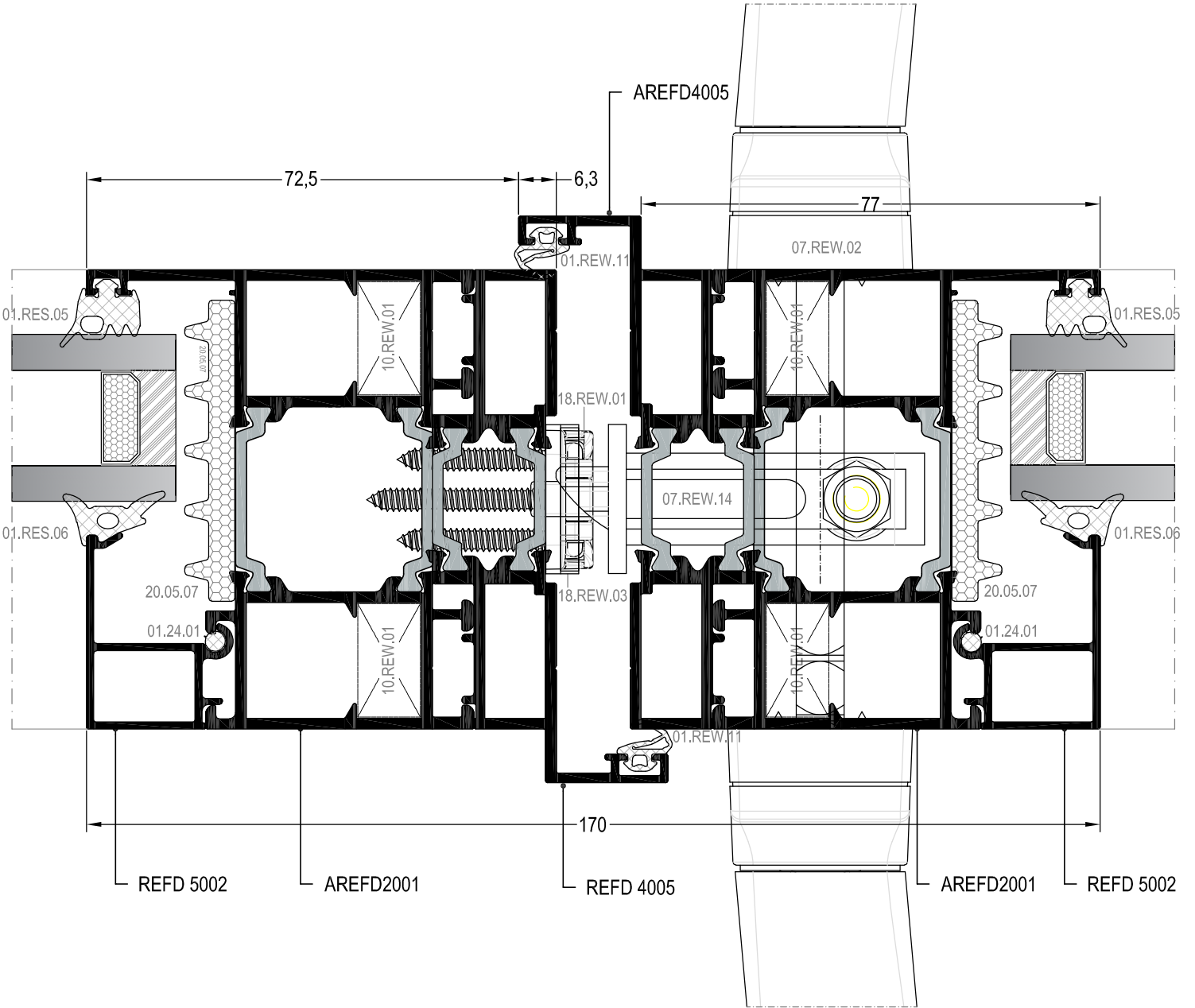
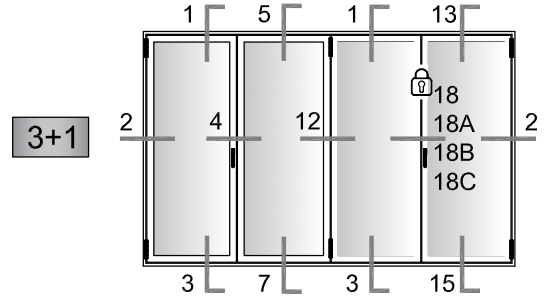

18B

DETAYI
DETAIL

▼ İÇ
(INSIDE)

DEAYLAR DETAILS

REFD77

KATLANIR KAPI DİŐA AÇILIM DETAYI
FOLDING DOOR OUTWARD OPENING DETAIL

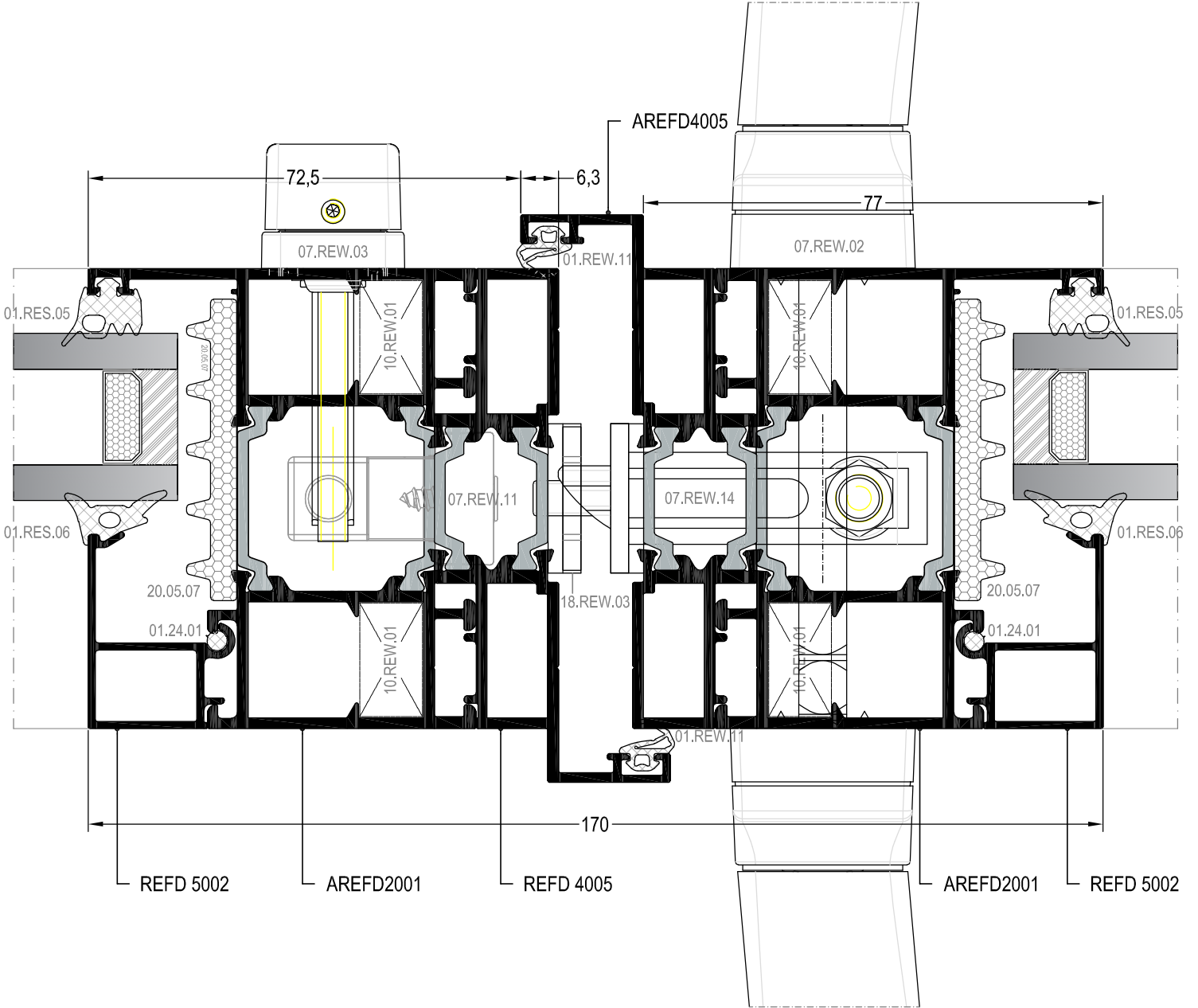
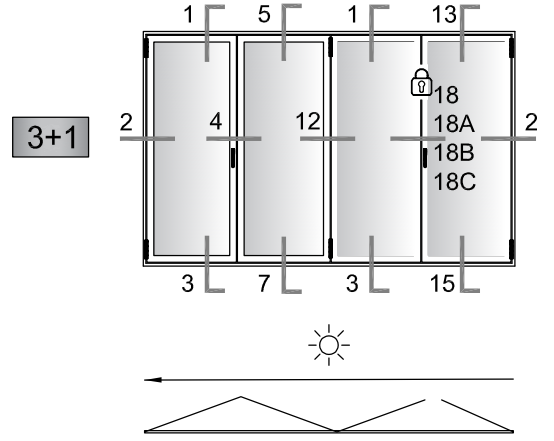

18C

DETAYI
DETAIL

▼ İÇ
(INSIDE)

DETAYLAR DETAILS

REFD77

KATLANIR KAPI DIŐA AÇILIM DETAYI
FOLDING DOOR OUTWARD OPENING DETAIL

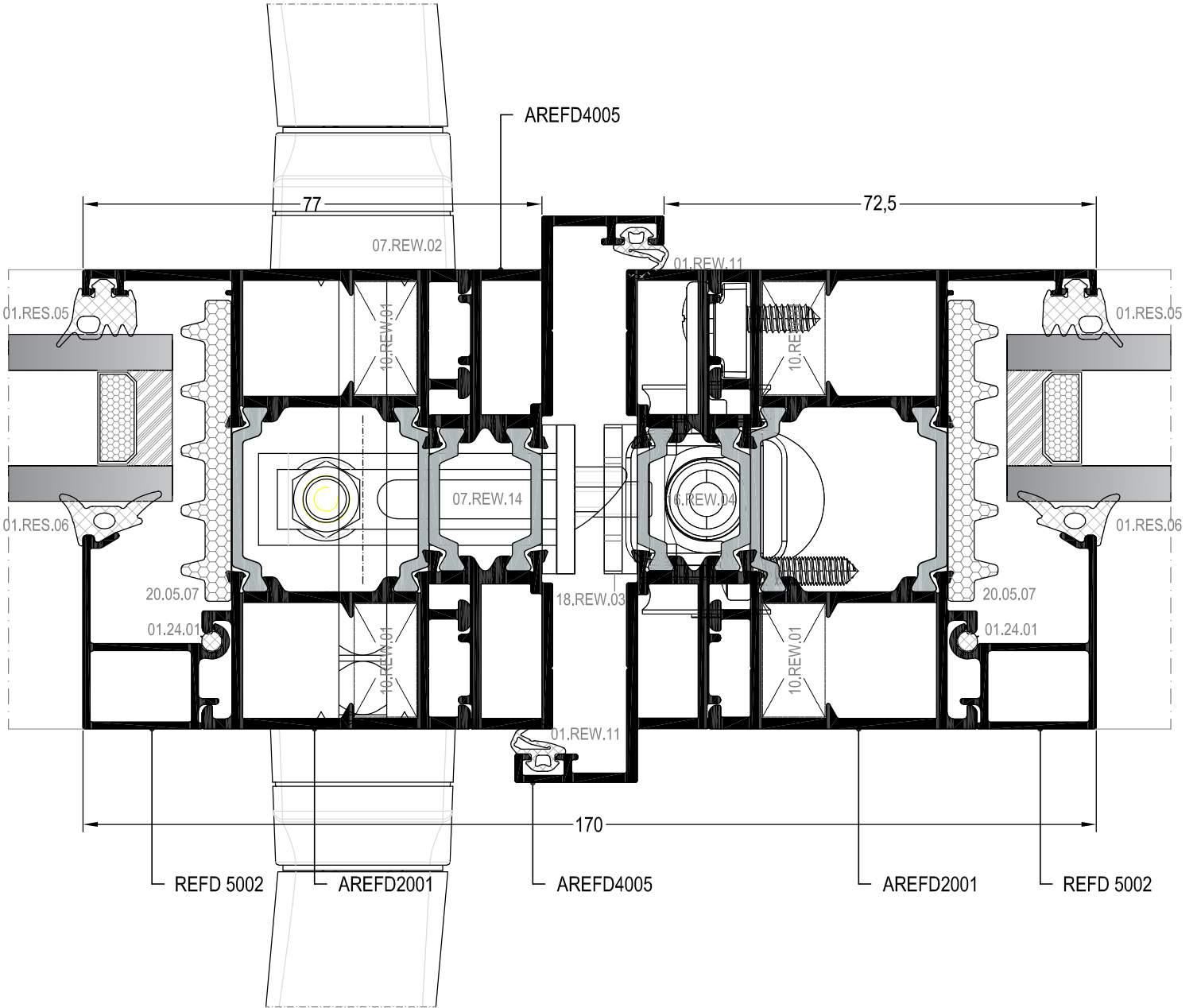
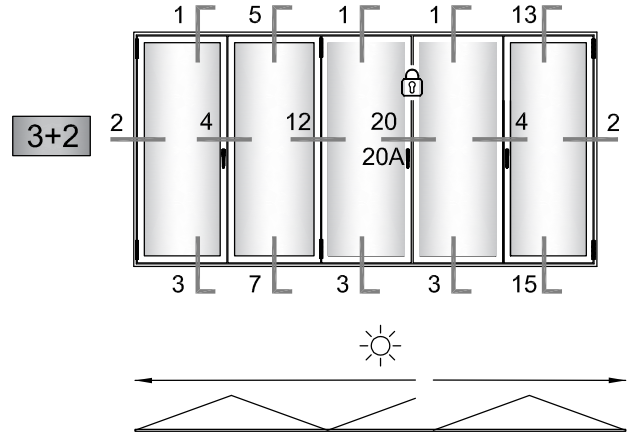

20A

DETAYI
DETAIL

▼ İÇ
(INSIDE)

MİMARİ KATALOG
ARCHITECTURAL CATALOGUE

Alüminyum Kapı Pencere ve Giydirme Cephe Sistemleri
Aluminium Window Doors and Facade Systems

REFD77

AKSESUARLAR

ACCESSORIES

10.REW.01

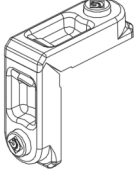

KÖŞE BAĞLANTI
CORNER JOINT

Malzeme / Material : Alüminyum/ Zamak
Aluminium/Zamak

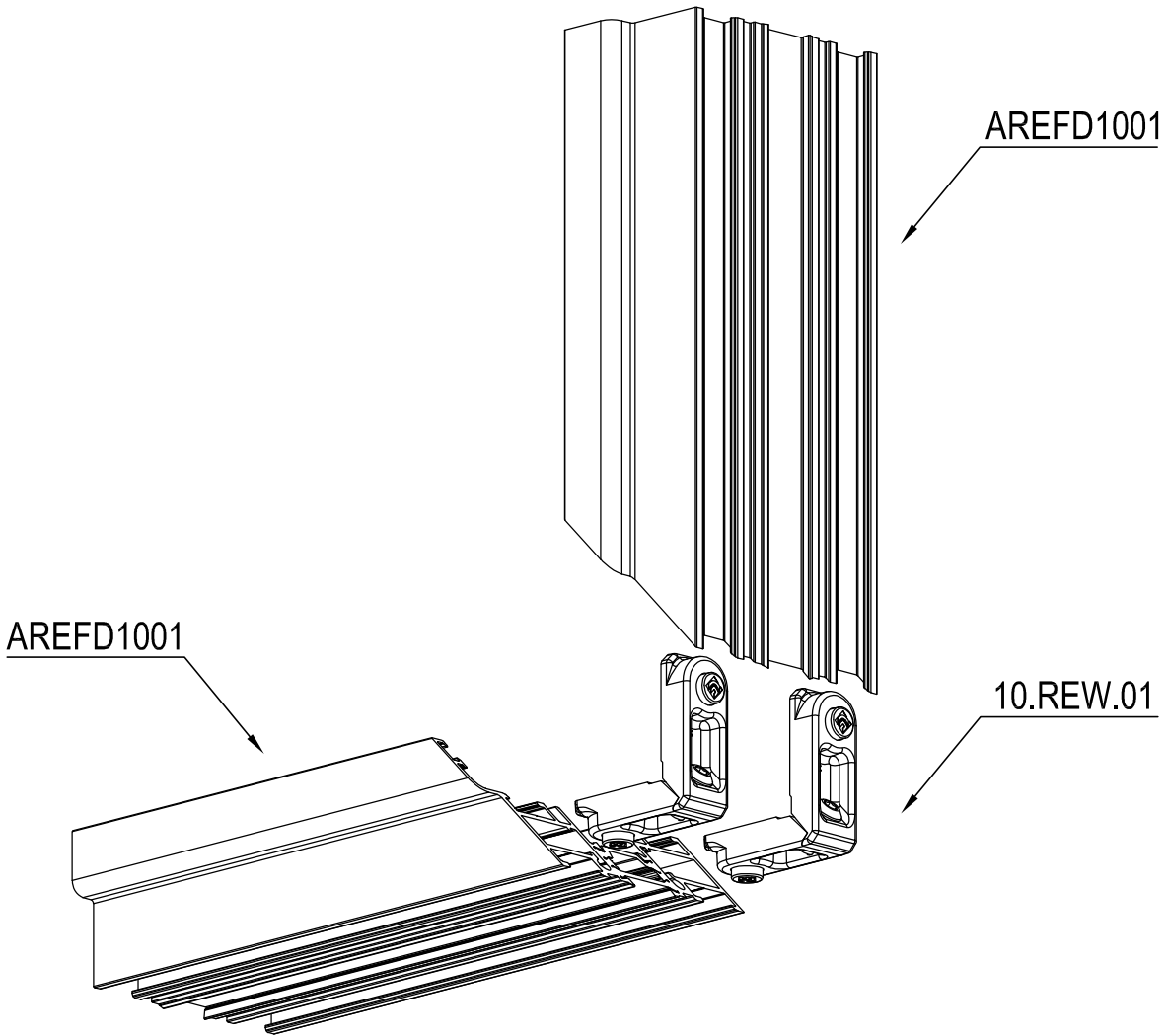

07.REW.01

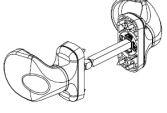

ÇİFT KARE MİLLİ KAPI KOLU
TWO-SIDE HANDLE

Malzeme / Material : XXX

07.REW.02

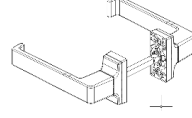

ÇİFT KARE MİLLİ KAPI KOLU
TWO-SIDE HANDLE

Malzeme / Material : Alüminyum/Zamak
Die-cast Aluminium/zamak

07.REW.03

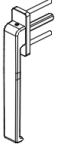

TEKLİ KARE MİLLİ KAPI KOLU
HANDE WITH REDUCED GRIP

Malzeme / Material : Alüminyum/Galvanize Çelik
Die-cast aluminium/ galvanised steel

07.REW.11



ÇİFT YÖNLÜ MEKANİZMA
TWO-WAYS MECHANISM AND GUIDE FOR THE BAR

Malzeme / Material : Zamak

07.REW.14



İKİ YÖNLÜ DİLLİ KİLİT MEKANİZMASI
MULTIPOINT LOCKING TWO-WAYS MOVEMENT
HANDLE OPERATED BACKSET 35 MM

07.REW.15

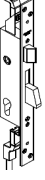

İKİ YÖNLÜ DİLLİ KİLİT MEKANİZMASI
BIDIRECTIONAL VERTICAL LOCK WITH
INTERNAL ROD-BACKSET 35

07.REW.12

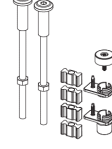

MEKANİZMA AKTARIM MİLİ 2MTx2 ADET
ROD ENDS AND GUIDE FOR THE BAR
THREADED ROD=2 MT

Malzeme / Material : Paslanmaz Çelik
Stainless Steel

07.REW.16

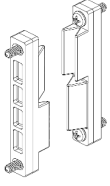

ARKA KİLİTLEME
ADDITIONAL THIRD LOCKING POINT

Malzeme / Material : ZAMAK

07.REW.20

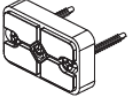

KAPI STOPERİ UZUN VİDALI
DOOR BUMPER

Malzeme / Material : Naylon / Nylon

07.REW.22

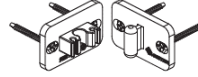

KAPI STOPERİ ÇİTLAMALI UZUN VİDALI
SASH STOPER

Malzeme / Material : Naylon / Nylon

18.REW.01

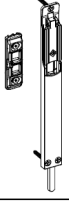

KAPI FIŞEK SÜRGÜ
LEVER BOLT H=220MM WITH STRIKER

Malzeme / Material : Alüminyum / Zamak
Aluminium / Zamak

18.REW.03



KİLİT KARŞILIĞI
COUNTER-PLATE FOR LOCK

18.REW.05*



ÇOKLU KİLİT KARŞILIĞI
COUNTERPLATE FOR DIVERTES MULTIPOINT LOCK

*Paket miktarı 2 adettir.
*There are 2 pieces in 1 package.

15.REW.01

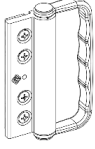

İÇE AÇILIM ÇEKME KOL
PULLING HANDLE FOR INTERNAL OPENING

Malzeme / Material : Alüminyum / Zamak
Aluminium / Zamak

15.REW.02

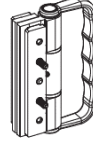

DIŞA AÇILIM MENTEŞELİ ÇEKME KOL
PULLING HANDLE FOR EXTERNAL OPENING

Malzeme / Material : Alüminyum / Zamak
Aluminium / Zamak

15.REW.03

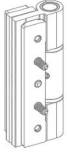

MENTEŞELİ AÇILIM
HINGE WITH INSERTING PLATE

Malzeme / Material : Alüminyum / Zamak
Aluminium / Zamak

UPPER HINGE POSITION FOR 15.REW.03, 15.REW.01, 16.REW.01

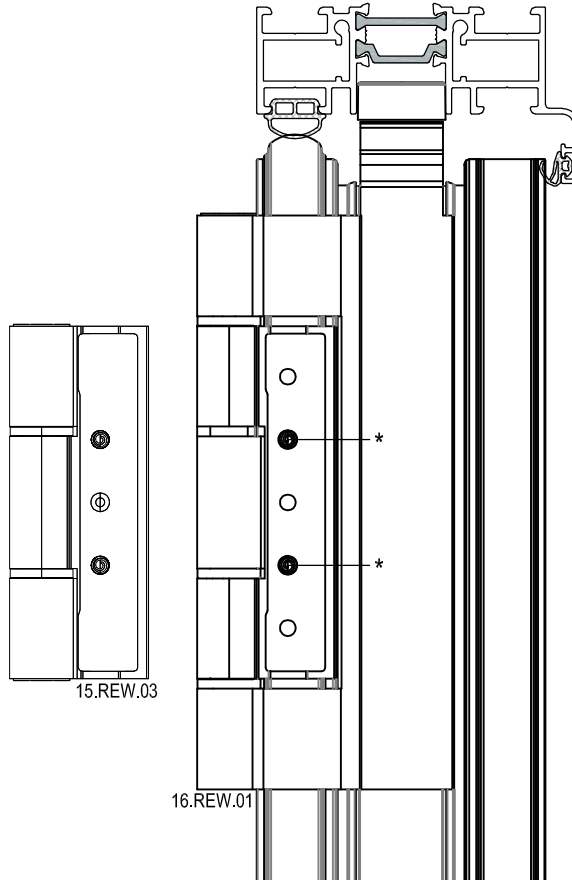

16.REW.01

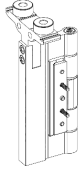

ÇİFTLİ ÜST RULMAN
UPPER-2 ROLLER

Malzeme / Material : Alüminyum / Zamak
Aluminium / Zamak

16.REW.02

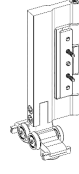

ÇİFTLİ ALT RULMAN
LOWER-2 ROLLER

Malzeme / Material : Alüminyum / Zamak
Aluminium / Zamak

16.REW.01

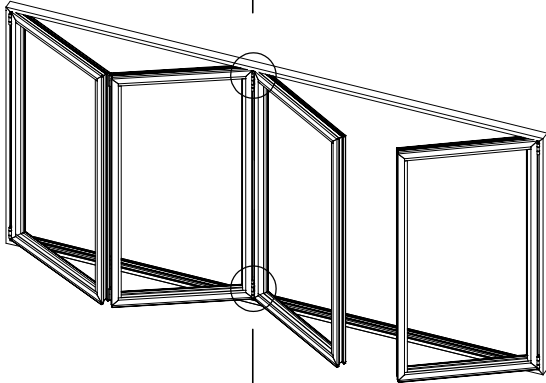
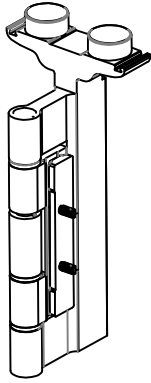

16.REW.02

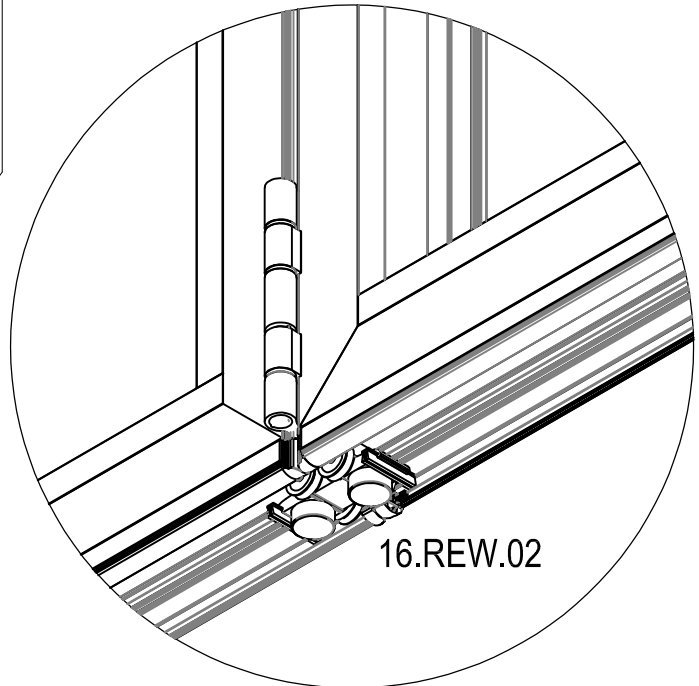
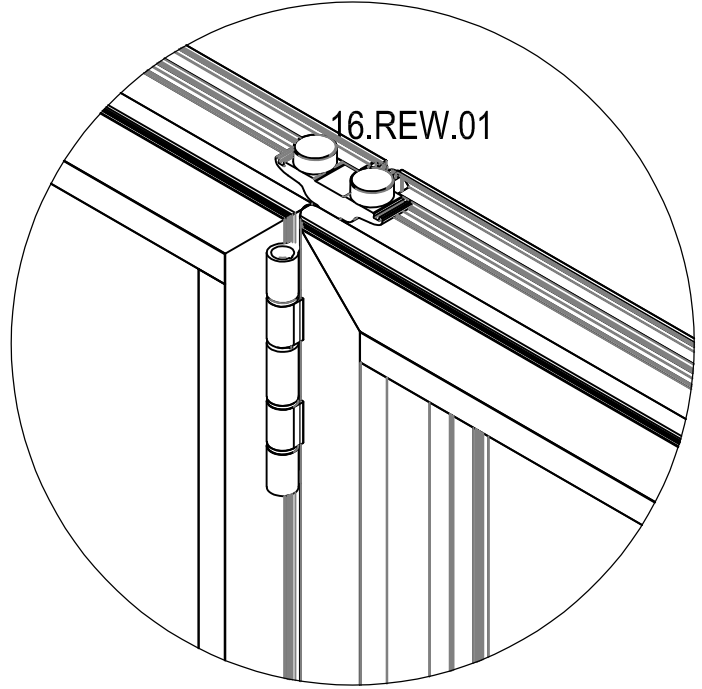
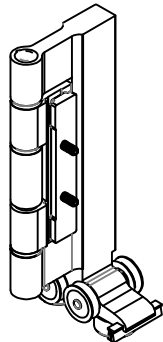

16.REW.03

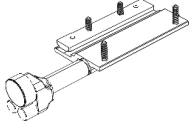

TEKLİ ÜST RULMAN
UPPER ROLLER FOR EVEN SASH

Malzeme / Material : Alüminyum / Zamak
Aluminium / Zamak

16.REW.04

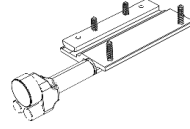

TEKLİ ALT RULMAN
LOWER ROLLER FOR EVEN SASH

Malzeme / Material : Alüminyum / Zamak
Aluminium / Zamak



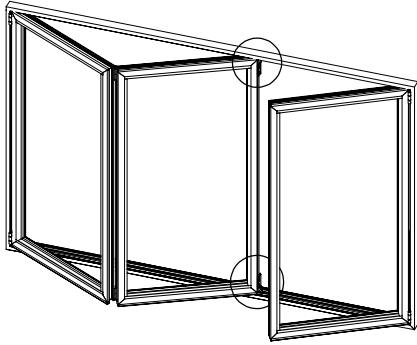
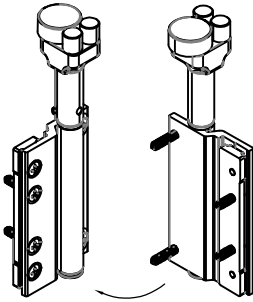



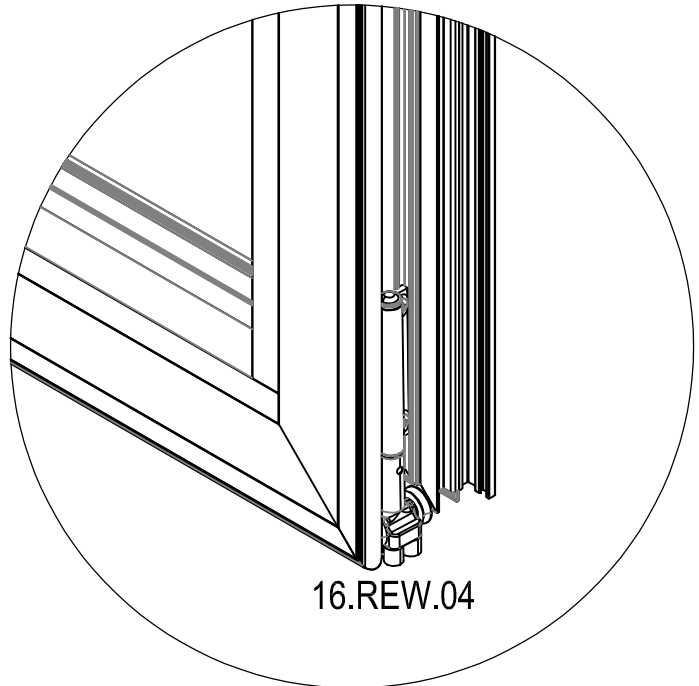
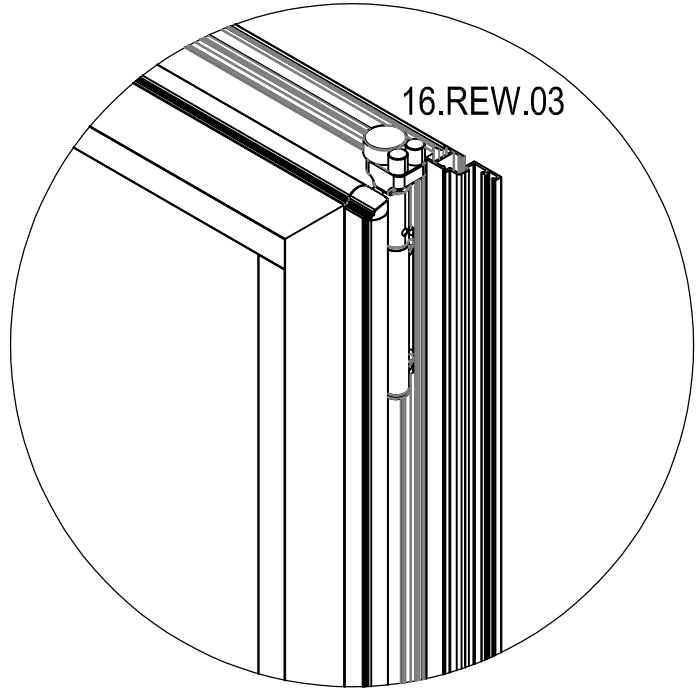
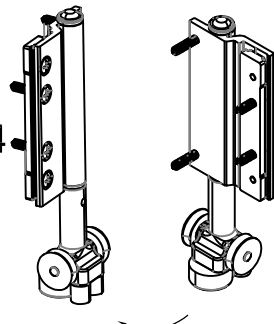



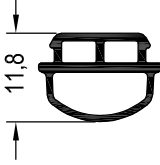
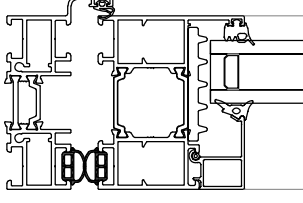



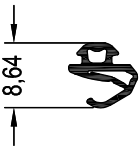
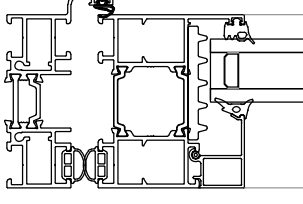



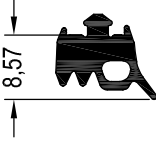
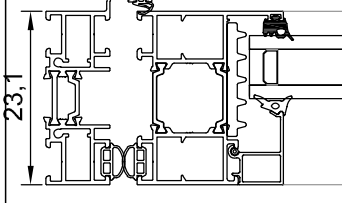



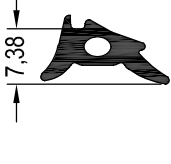
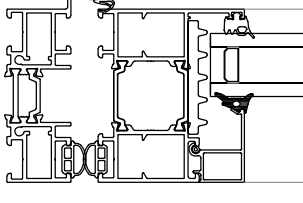



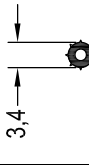
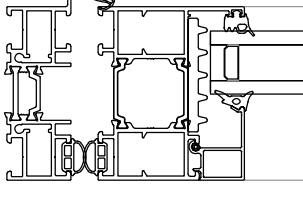

16.REW.03

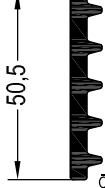
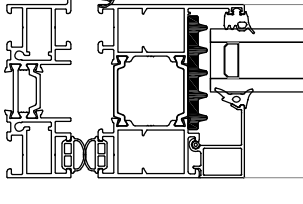

16.REW.04



FİTİLLER / GASKETS

KOD CODE	GÖRSEL DRAWING	DETAY DETAIL	TEKNİK VERİLER TECHNICAL DATA		
01.REW.10 EPDM FİTİL EPDM GASKET			 BİRİM AĞIRLIK UNIT WEIGHT (gr/mt)	97	
			 MALZEME MATERIAL	EPDM	
			 PAKET AĞIRLIK PACKAGE WEIGHT (kg/pu)	15	
			 PAKET UZUNLUK PACKAGE LENGTH (m/pu)	154	
01.REW.11 EPDM FİTİL EPDM GASKET			 BİRİM AĞIRLIK UNIT WEIGHT (gr/mt)	48	
			 MALZEME MATERIAL	EPDM	
			 PAKET AĞIRLIK PACKAGE WEIGHT (kg/pu)	15	
			 PAKET UZUNLUK PACKAGE LENGTH (m/pu)	312	
01.RES.05 EPDM FİTİL EPDM GASKET			 BİRİM AĞIRLIK UNIT WEIGHT (gr/mt)	95	
			 MALZEME MATERIAL	EPDM	
			 PAKET AĞIRLIK PACKAGE WEIGHT (kg/pu)	15	
			 PAKET UZUNLUK PACKAGE LENGTH (m/pu)	157	
01.RES.06 EPDM FİTİL EPDM GASKET			 BİRİM AĞIRLIK UNIT WEIGHT (gr/mt)	74	
			 MALZEME MATERIAL	EPDM	
			 PAKET AĞIRLIK PACKAGE WEIGHT (kg/pu)	15	
			 PAKET UZUNLUK PACKAGE LENGTH (m/pu)	202	
01.24.01 EPDM FİTİL EPDM GASKET			 BİRİM AĞIRLIK UNIT WEIGHT (gr/mt)	10	
			 MALZEME MATERIAL	EPDM	
			 PAKET AĞIRLIK PACKAGE WEIGHT (kg/pu)	15	
			 PAKET UZUNLUK PACKAGE LENGTH (m/pu)	1500	
20.05.07 YALITIM ELEMANI INSULATION PIECE			 BİRİM AĞIRLIK UNIT WEIGHT (gr/mt)		
			 MALZEME MATERIAL	EPDM KÖPÜK	
			 PAKET AĞIRLIK PACKAGE WEIGHT (kg/pu)		
			 PAKET UZUNLUK PACKAGE LENGTH (m/pu)		
			 BİRİM AĞIRLIK UNIT WEIGHT (gr/mt)		
			 MALZEME MATERIAL		
			 PAKET AĞIRLIK PACKAGE WEIGHT (kg/pu)		
			 PAKET UZUNLUK PACKAGE LENGTH (m/pu)		

KOD CODE	AÇIKLAMA DESCRIPTION	2+0		2+1		2+2	
		8	8A	8	8A	8	8A
07.REW.01 veya / or 07.REW.02	ÇİFTLİ KARE MİLLİ KAPI KOLU TWO-SIDE HANDLE				1		
07.REW.03	TEKLİ KARE MİLLİ KAPI KOLU HANDLE WITH REDUCED GRIP	1	2	1		2	
07.REW.11	ÇİFT YÖNLÜ MEKANİZMA TWO-WAYS MECHANISM AND GUIDE FOR THE BAR	1	2	1		2	
07.REW.14 veya / or	İKİ YÖNLÜ DİLLİ KİLİT MEKANİZMASI MULTIPOINT LOCKING TWO-WAYS MOVEMENT						
07.REW.15 veya / or	İKİ YÖNLÜ BOLT KİLİT MEKANİZMASI BIDIRECTIONAL VERTICAL LOCK WITH INTERNAL				1		
07.REW.17	ÇOKLU KİLİT MEKANİZMASI 3 LOCKING POINT VERTICAL LOCK						
07.REW.12	MEKANİZMA AKTARIM MİLLİ 2mt x 2ad THREADED ROD L=2mt	1	2	2		2	
07.REW.16	ARKA KİLİTLEME ADDITIONAL THIRD LOCKING POINT	1	1	1		2	
18.REW.01	KAPI FİŞEK SÜRGÜ LEVER BOLT H=220MM WITH STRIKER						
18.REW.03	KİLİT KARŞILIĞI COUNTER-PLATE FOR LOCK				1		
18.REW.05*	ÇOKLU KİLİT KARŞILIĞI COUNTERPLATE FOR DIVERTE MULTIPOINT LOCK				2		
15.REW.01	İÇE AÇILIM ÇEKME KOL PULLING HANDLE FOR INTERNAL OPENING						
15.REW.02	DIŞA AÇILIM MENTEŞELİ ÇEKME KOL PULLING HANDLE FOR EXTERNAL OPENING	1	1	1		2	
15.REW.03	MENTEŞE (İÇE AÇILIM) HINGE WITH INSERTING PLATE (INWARD OPENING)	6	9	9		12	
15.REW.03	MENTEŞE (DIŞA AÇILIM) HINGE WITH INSERTING PLATE (OUTWARD OPENING)	5	8	8		10	
16.REW.01	ÇİFTLİ ÜST RULMAN UPPER ROLLER						
16.REW.02	ÇİFTLİ ALT RULMAN LOWER ROLLER						
16.REW.03	TEKLİ ÜST RULMAN UPPER ROLLER FOR EVEN SASH	1	1	1		2	
16.REW.04	TEKLİ ALT RULMAN LOWER ROLLER FOR EVEN SASH	1	1	1		2	
07.REW.20	KAPI STOPERİ UZUN VİDALI DOOR BUMPER						
07.REW.22	KAPI STOPERİ ÇİTLAMALI UZUN VİDALI SASH STOPPER						

AKSESUARLAR ACCESSORIES

REFD77

KOD CODE	AÇIKLAMA DESCRIPTION	3+0		3+1				3+2	
		14	14A ☺	18	18A	18B ☺	18C ☺	20	20A ☺
07.REW.01 veya / or 07.REW.02	ÇİFTLİ KARE MİLLİ KAPI KOLU TWO-SIDE HANDLE		1			1	1		1
07.REW.03	TEKLİ KARE MİLLİ KAPI KOLU HANDLE WITH REDUCED GRIP	2	1	2	3	1	2	3	2
07.REW.11	ÇİFT YÖNLÜ MEKANİZMA TWO-WAYS MECHANISM AND GUIDE FOR THE BAR	2	1	2	3	1	2	3	2
07.REW.14	İKİ YÖNLÜ DİLLİ KİLİT MEKANİZMASI MULTIPOINT LOCKING TWO-WAYS MOVEMENT								
07.REW.15 veya / or	İKİ YÖNLÜ BOLT KİLİT MEKANİZMASI BIDIRECTIONAL VERTICAL LOCK WITH INTERNAL		1			1	1		1
07.REW.17	ÇOKLU KİLİT MEKANİZMASI 3 LOCKING POINT VERTICAL LOCK								
07.REW.12	MEKANİZMA AKTARIM MİLLİ 2mt x 2ad THREADED ROD L=2mt	2	2	2	3	2	3	3	3
07.REW.16	ARKA KİLİTLEME ADDITIONAL THIRD LOCKING POINT	2	2	2	2	2	2	3	3
18.REW.01	KAPI FİŞEK SÜRGÜ LEVER BOLT H=220MM WITH STRIKER			2		2			
18.REW.03	KİLİT KARŞILIĞI COUNTER-PLATE FOR LOCK		1			1	1		1
18.REW.05*	ÇOKLU KİLİT KARŞILIĞI COUNTERPLATE FOR DIVERTE MULTIPOINT LOCK		2			2	2		2
15.REW.01	İÇE AÇILIM ÇEKME KOL PULLING HANDLE FOR INTERNAL OPENING	1	1	1	1	1	1	2	2
15.REW.02	DIŞA AÇILIM MENTEŞELİ ÇEKME KOL PULLING HANDLE FOR EXTERNAL OPENING								
15.REW.03	MENTEŞE (İÇE AÇILIM) HINGE WITH INSERTING PLATE (INWARD OPENING)	7	7	10	10	10	10	13	13
15.REW.03	MENTEŞE (DIŞA AÇILIM) HINGE WITH INSERTING PLATE (OUTWARD OPENING)	6	6	9	9	9	9	11	11
16.REW.01	ÇİFTLİ ÜST RULMAN UPPER ROLLER	1	1	1	1	1	1	1	1
16.REW.02	ÇİFTLİ ALT RULMAN LOWER ROLLER	1	1	1	1	1	1	1	1
16.REW.03	TEKLİ ÜST RULMAN UPPER ROLLER FOR EVEN SASH							1	1
16.REW.04	TEKLİ ALT RULMAN LOWER ROLLER FOR EVEN SASH							1	1
07.REW.20	KAPI STOPERİ UZUN VİDALI DOOR BUMPER		2						2
07.REW.22	KAPI STOPERİ ÇİTLAMALI UZUN VİDALI SASH STOPPER	1	1		1		1	1	1

AKSESUARLAR ACCESSORIES

REFD77

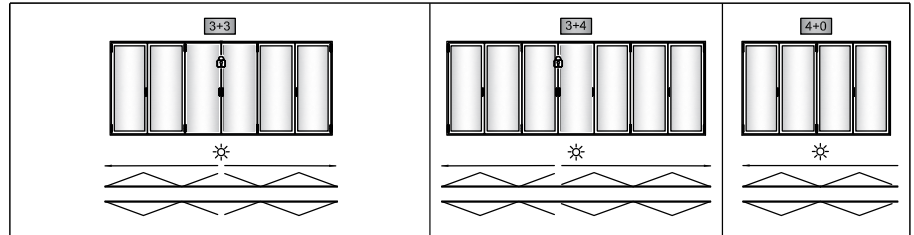

KOD CODE	AÇIKLAMA DESCRIPTION	18 ☺	18A	18B ☺	18C ☺	20	20A ☺	
07.REW.01 veya / or 07.REW.02	ÇİFTLİ KARE MİLLİ KAPI KOLU TWO-SIDE HANDLE			1	1		1	
07.REW.03	TEKLİ KARE MİLLİ KAPI KOLU HANDLE WITH REDUCED GRIP	3	4	2	3	4	3	2
07.REW.11	ÇİFT YÖNLÜ MEKANİZMA TWO-WAYS MECHANISM AND GUIDE FOR THE BAR	3	4	2	3	4	3	2
07.REW.14 veya / or	İKİ YÖNLÜ DİLLİ KİLİT MEKANİZMASI MULTIPOINT LOCKING TWO-WAYS MOVEMENT							
07.REW.15 veya / or	İKİ YÖNLÜ BOLT KİLİT MEKANİZMASI BIDIRECTIONAL VERTICAL LOCK WITH INTERNAL			1	1		1	
07.REW.17	ÇOKLU KİLİT MEKANİZMASI 3 LOCKING POINT VERTICAL LOCK							
07.REW.12	MEKANİZMA AKTARIM MİLLİ 2mt x 2ad THREADED ROD L=2mt	3	4	3	4	4	4	2
07.REW.16	ARKA KİLİTLEME ADDITIONAL THIRD LOCKING POINT	4	4	4	4	5	5	3
18.REW.01	KAPI FİŞEK SÜRGÜ LEVER BOLT H=220MM WITH STRIKER	2		2				
18.REW.03	KİLİT KARŞILIĞI COUNTER-PLATE FOR LOCK			1	1		1	
18.REW.05*	ÇOKLU KİLİT KARŞILIĞI COUNTERPLATE FOR DIVERTE MULTIPOINT LOCK			2	2		2	
15.REW.01	İÇE AÇILIM ÇEKME KOL PULLING HANDLE FOR INTERNAL OPENING	2	2	2	2	3	3	2
15.REW.02	DIŞA AÇILIM MENTEŞELİ ÇEKME KOL PULLING HANDLE FOR EXTERNAL OPENING							
15.REW.03	MENTEŞE (İÇE AÇILIM) HINGE WITH INSERTING PLATE (INWARD OPENING)	14	14	14	14	17	17	10
15.REW.03	MENTEŞE (DIŞA AÇILIM) HINGE WITH INSERTING PLATE (OUTWARD OPENING)	12	12	12	12	14	14	8
16.REW.01	ÇİFTLİ ÜST RULMAN UPPER ROLLER	2	2	2	2	2	2	1
16.REW.02	ÇİFTLİ ALT RULMAN LOWER ROLLER	2	2	2	2	2	2	1
16.REW.03	TEKLİ ÜST RULMAN UPPER ROLLER FOR EVEN SASH					1	1	1
16.REW.04	TEKLİ ALT RULMAN LOWER ROLLER FOR EVEN SASH					1	1	1
07.REW.20	KAPI STOPERİ UZUN VİDALI DOOR BUMPER			2	2		2	
07.REW.22	KAPI STOPERİ ÇİTLAMALI UZUN VİDALI SASH STOPPER	1	2	1	2	1	1	

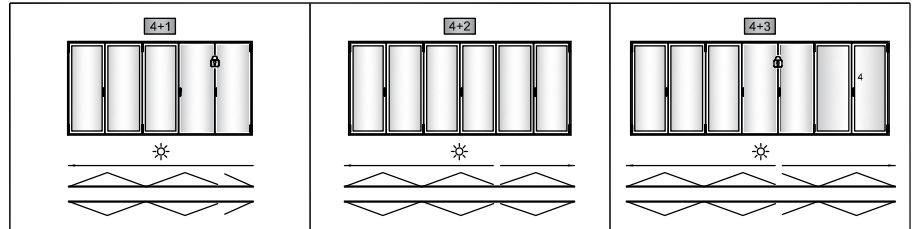

KOD CODE	AÇIKLAMA DESCRIPTION	8	8A ☒		8	8A ☒
07.REW.01 veya / or 07.REW.02	ÇİFTLİ KARE MİLLİ KAPI KOLU TWO-SIDE HANDLE		1			1
07.REW.03	TEKLİ KARE MİLLİ KAPI KOLU HANDLE WITH REDUCED GRIP	3	2	3	4	3
07.REW.11	ÇİFT YÖNLÜ MEKANİZMA TWO-WAYS MECHANISM AND GUIDE FOR THE BAR	3	2	3	4	3
07.REW.14 veya / or	İKİ YÖNLÜ DİLLİ KİLİT MEKANİZMASI MULTIPOINT LOCKING TWO-WAYS MOVEMENT					
07.REW.15 veya / or	İKİ YÖNLÜ BOLT KİLİT MEKANİZMASI BIDIRECTIONAL VERTICAL LOCK WITH INTERNAL		1			1
07.REW.17	ÇOKLU KİLİT MEKANİZMASI 3 LOCKING POINT VERTICAL LOCK					
07.REW.12	MEKANİZMA AKTARIM MİLLİ 2mt x 2ad THREADED ROD L=2mt	3	3	3	4	4
07.REW.16	ARKA KİLİTLEME ADDITIONAL THIRD LOCKING POINT	3	3	4	5	5
18.REW.01	KAPI FİŞEK SÜRGÜ LEVER BOLT H=220MM WITH STRIKER					
18.REW.03	KİLİT KARŞILIĞI COUNTER-PLATE FOR LOCK		1			1
18.REW.05*	ÇOKLU KİLİT KARŞILIĞI COUNTERPLATE FOR DIVERTES MULTIPOINT LOCK		2			2
15.REW.01	İÇE AÇILIM ÇEKME KOL PULLING HANDLE FOR INTERNAL OPENING	2	2	3	3	3
15.REW.02	DIŞA AÇILIM MENTEŞELİ ÇEKME KOL PULLING HANDLE FOR EXTERNAL OPENING					
15.REW.03	MENTEŞE (İÇE AÇILIM) HINGE WITH INSERTING PLATE (INWARD OPENING)	13	13	16	17	17
15.REW.03	MENTEŞE (DIŞA AÇILIM) HINGE WITH INSERTING PLATE (OUTWARD OPENING)	11	11	13	14	14
16.REW.01	ÇİFTLİ ÜST RULMAN UPPER ROLLER	1	1	1	2	2
16.REW.02	ÇİFTLİ ALT RULMAN LOWER ROLLER	1	1	1	2	2
16.REW.03	TEKLİ ÜST RULMAN UPPER ROLLER FOR EVEN SASH	1	1	2	1	1
16.REW.04	TEKLİ ALT RULMAN LOWER ROLLER FOR EVEN SASH	1	1	2	1	1
07.REW.20	KAPI STOPERİ UZUN VİDALI DOOR BUMPER					2
07.REW.22	KAPI STOPERİ ÇİTLAMALI UZUN VİDALI SASH STOPPER				1	1

AKSESUARLAR ACCESSORIES

REFD77

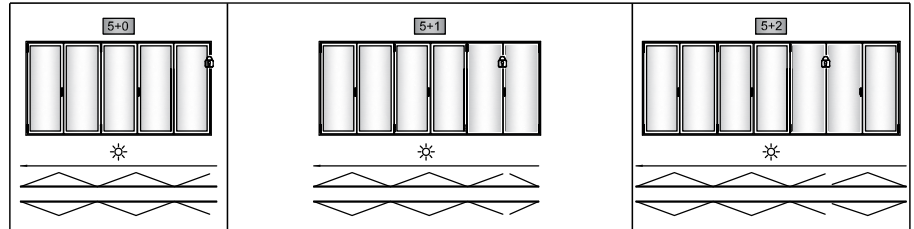

KOD CODE	AÇIKLAMA DESCRIPTION	14 ☺	14A ☺	18	18A	18B ☺	18C ☺	20	20A ☺
07.REW.01 veya / or 07.REW.02	ÇİFTLİ KARE MİLLİ KAPI KOLU TWO-SIDE HANDLE		1			1	1		1
07.REW.03	TEKLİ KARE MİLLİ KAPI KOLU HANDLE WITH REDUCED GRIP	3	2	3	4	2	3	4	4
07.REW.11	ÇİFT YÖNLÜ MEKANİZMA TWO-WAYS MECHANISM AND GUIDE FOR THE BAR	3	2	3	4	2	3	4	4
07.REW.14 veya / or	İKİ YÖNLÜ DİLLİ KİLİT MEKANİZMASI MULTIPOINT LOCKING TWO-WAYS MOVEMENT								
07.REW.15 veya / or	İKİ YÖNLÜ BOLT KİLİT MEKANİZMASI BIDIRECTIONAL VERTICAL LOCK WITH INTERNAL		1			1	1		1
07.REW.17	ÇOKLU KİLİT MEKANİZMASI 3 LOCKING POINT VERTICAL LOCK								
07.REW.12	MEKANİZMA AKTARIM MİLLİ 2mt x 2ad THREADED ROD L=2mt	3	3	3	4	3	4	4	5
07.REW.16	ARKA KİLİTLEME ADDITIONAL THIRD LOCKING POINT	4	4	4	4	4	4	5	5
18.REW.01	KAPI FİŞEK SÜRGÜ LEVER BOLT H=220MM WITH STRIKER			2		2			
18.REW.03	KİLİT KARŞILIĞI COUNTER-PLATE FOR LOCK		1			1	1		1
18.REW.05*	ÇOKLU KİLİT KARŞILIĞI COUNTERPLATE FOR DIVERTE MULTIPOINT LOCK		2			2	2		2
15.REW.01	İÇE AÇILIM ÇEKME KOL PULLING HANDLE FOR INTERNAL OPENING								
15.REW.02	DIŞA AÇILIM MENTEŞELİ ÇEKME KOL PULLING HANDLE FOR EXTERNAL OPENING	2	2	2	2	2	2	3	3
15.REW.03	MENTEŞE (İÇE AÇILIM) HINGE WITH INSERTING PLATE (INWARD OPENING)	11	11	14	14	14	14	17	17
15.REW.03	MENTEŞE (DIŞA AÇILIM) HINGE WITH INSERTING PLATE (OUTWARD OPENING)	9	9	12	12	12	12	14	14
16.REW.01	ÇİFTLİ ÜST RULMAN UPPER ROLLER	2	2	2	2	2	2	2	2
16.REW.02	ÇİFTLİ ALT RULMAN LOWER ROLLER	2	2	2	2	2	2	2	2
16.REW.03	TEKLİ ÜST RULMAN UPPER ROLLER FOR EVEN SASH							1	1
16.REW.04	TEKLİ ALT RULMAN LOWER ROLLER FOR EVEN SASH							1	1
07.REW.20	KAPI STOPERİ UZUN VİDALI DOOR BUMPER		2						2
07.REW.22	KAPI STOPERİ ÇİTLAMALI UZUN VİDALI SASH STOPPER	2	2	1	2	1	2	2	2

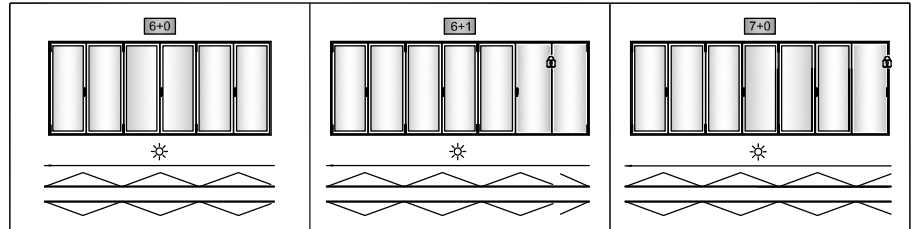

KOD CODE	AÇIKLAMA DESCRIPTION		8	8A ☒	14	14A ☒
07.REW.01 veya / or 07.REW.02	ÇİFTLİ KARE MİLLİ KAPI KOLU TWO-SIDE HANDLE			1		1
07.REW.03	TEKLİ KARE MİLLİ KAPI KOLU HANDLE WITH REDUCED GRIP	3	4	3	4	3
07.REW.11	ÇİFT YÖNLÜ MEKANİZMA TWO-WAYS MECHANISM AND GUIDE FOR THE BAR	3	4	3	4	3
07.REW.14 veya / or	İKİ YÖNLÜ DİLLİ KİLİT MEKANİZMASI MULTIPOINT LOCKING TWO-WAYS MOVEMENT					
07.REW.15 veya / or	İKİ YÖNLÜ BOLT KİLİT MEKANİZMASI BIDIRECTIONAL VERTICAL LOCK WITH INTERNAL			1		1
07.REW.17	ÇOKLU KİLİT MEKANİZMASI 3 LOCKING POINT VERTICAL LOCK					
07.REW.12	MEKANİZMA AKTARIM MİLLİ 2mt x 2ad THREADED ROD L=2mt	3	4	4	4	4
07.REW.16	ARKA KİLİTLEME ADDITIONAL THIRD LOCKING POINT	5	5	5	6	6
18.REW.01	KAPI FİŞEK SÜRGÜ LEVER BOLT H=220MM WITH STRIKER					
18.REW.03	KİLİT KARŞILIĞI COUNTER-PLATE FOR LOCK			1		1
18.REW.05*	ÇOKLU KİLİT KARŞILIĞI COUNTERPLATE FOR DIVERTES MULTIPOINT LOCK			2		2
15.REW.01	İÇE AÇILIM ÇEKME KOL PULLING HANDLE FOR INTERNAL OPENING	3	3	3	3	3
15.REW.02	DIŞA AÇILIM MENTEŞELİ ÇEKME KOL PULLING HANDLE FOR EXTERNAL OPENING					
15.REW.03	MENTEŞE (İÇE AÇILIM) HINGE WITH INSERTING PLATE (INWARD OPENING)	14	17	17	15	15
15.REW.03	MENTEŞE (DIŞA AÇILIM) HINGE WITH INSERTING PLATE (OUTWARD OPENING)	11	14	14	12	12
16.REW.01	ÇİFTLİ ÜST RULMAN UPPER ROLLER	2	2	2	3	3
16.REW.02	ÇİFTLİ ALT RULMAN LOWER ROLLER	2	2	2	3	3
16.REW.03	TEKLİ ÜST RULMAN UPPER ROLLER FOR EVEN SASH	1	1	1		
16.REW.04	TEKLİ ALT RULMAN LOWER ROLLER FOR EVEN SASH	1	1	1		
07.REW.20	KAPI STOPERİ UZUN VİDALI DOOR BUMPER					2
07.REW.22	KAPI STOPERİ ÇİTLAMALI UZUN VİDALI SASH STOPPER				3	3