

MİMARİ KATALOG
ARCHITECTURAL CATALOGUE

Alüminyum Kapı Pencere ve Giydirme Cephe Sistemleri
Aluminium Window Doors and Facade Systems



RF G46+

MİMARİ KATALOG
ARCHITECTURAL CATALOGUE

Alüminyum Kapı Pencere ve Giydirme Cephe Sistemleri
Aluminium Window Doors and Facade Systems



Rescara Sistem Detayları
Rescara System Details

RFG46+

PROFİLLER

PROFILES

KOD/ CODE	AĞIRLIK (kg/m)/ WEIGHT	Jxx cm ⁴	Jyy cm ⁴	L m
Rfg46 F 01	1,494	16,903	20,088	6
Rfg46 F 03	1,734	21,950	31,799	6
Rfg46 F 04	2,156	84,492	39,306	6

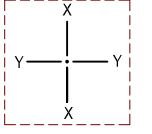

Rfg46 F 01

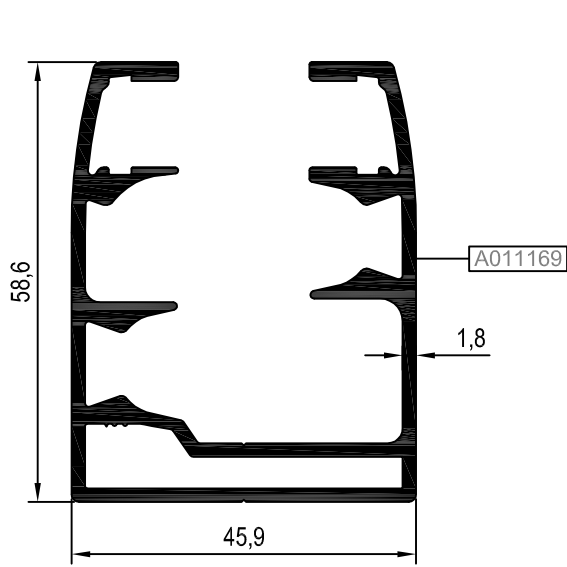

Rfg46 F 03

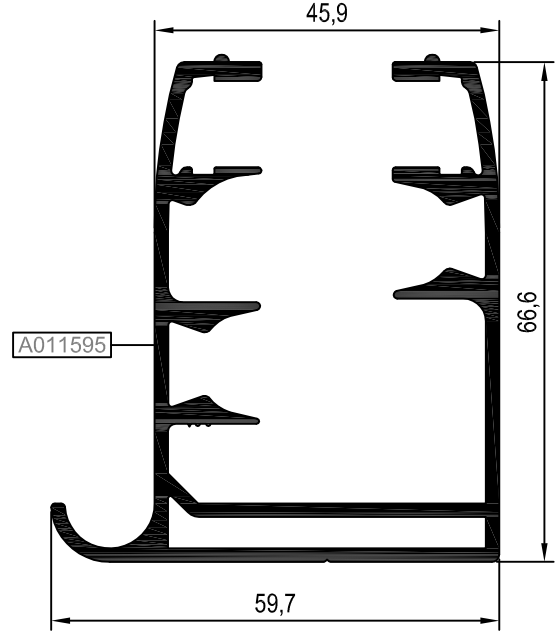

Rfg46 F 04

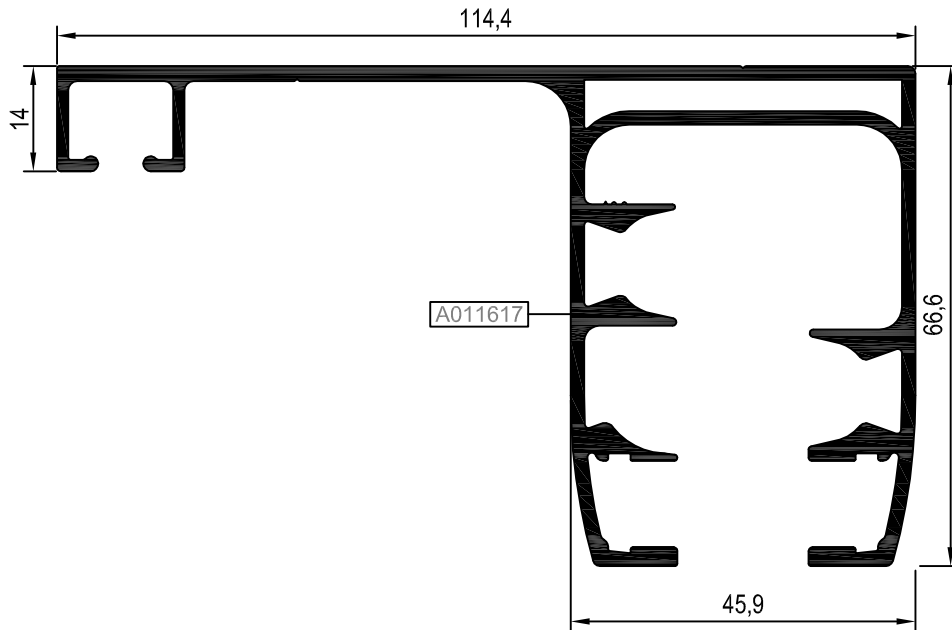

KOD/ CODE	AĞIRLIK (kg/m)/ WEIGHT	Jxx cm4	Jyy cm4	L m
Rfg46 F 05	0,524	3,440	1,607	6
Rfg46 V 06	0,984	4,066	7,745	6

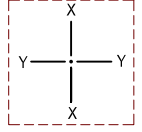

Rfg46 F 05

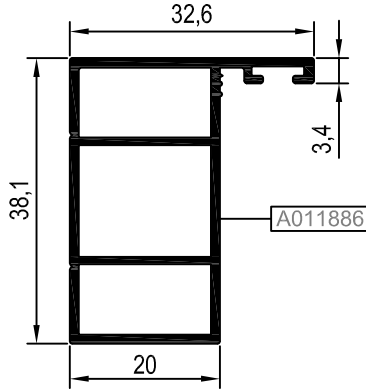

Rfg46 V 06

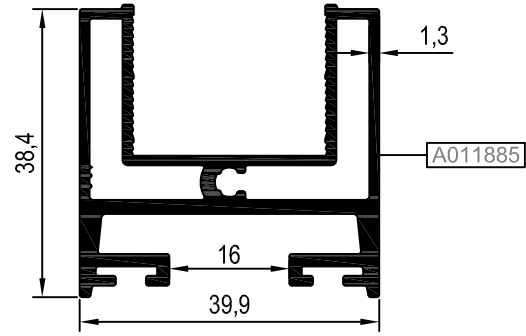

STOKTA BULUNAN SİSTEM PROFİLLERİNİN LİSTESİ (LIST OF SYSTEM PROFILES IN STOCK)

Nr	MIN. SİPARİŞ MİKTARI MIN. ORDER QUANTITY
RFG46 F 01	A011169 75 kg
RFG46 F 03	A011595 75 kg

* STOKTA BULUNMAYAN TÜM PROFİLLER İÇİN MİNİMUM SİPARİŞ MİKTARI 300 KG'DIR.
MINIMUM ORDER QUANTITY FOR ALL THE PROFILES THAT ARE NOT IN STOCK IS 300 KG.

KOD/ CODE	AĞIRLIK (kg/m)/ WEIGHT	Jxx cm4	Jyy cm4	L m
Rfg46 A 09	0,185	0,852	0,190	6
Rfg46 A 10	0,271	1,520	0,696	6
Rfg46 A 11	0,356	2,790	1,006	6
Rfg46 A 12	0,283	1,710	0,343	6
Rfg46 A 13	0,631	5,556	3,801	6

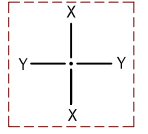

Rfg46 A 09

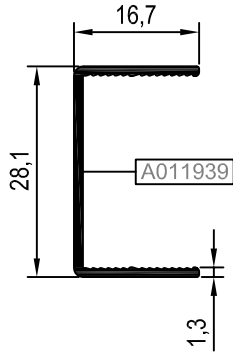

Rfg46 A 10

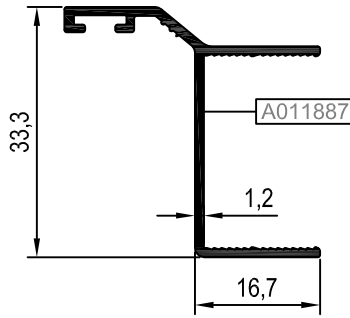

Rfg46 A 11

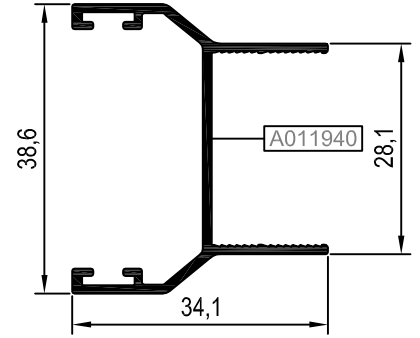

Rfg46 A 12

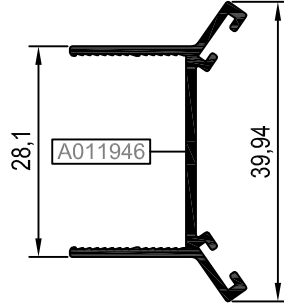

Rfg46 A 13

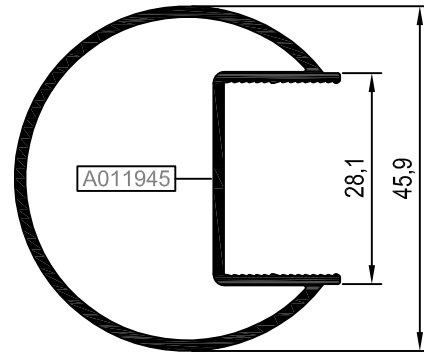

MİMARİ KATALOG
ARCHITECTURAL CATALOGUE

Alüminyum Kapı Pencere ve Giydirme Cephe Sistemleri
Aluminium Window Doors and Facade Systems



Rescara Sistem Detayları
Rescara System Details

RFG46+

DETAYLAR

DETAILS

① DETAYI
DETAIL

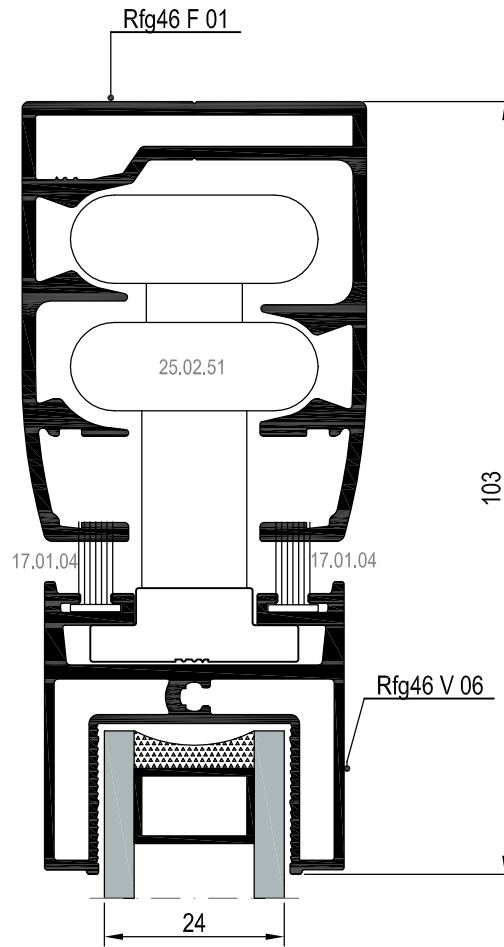

② DETAYI
DETAIL

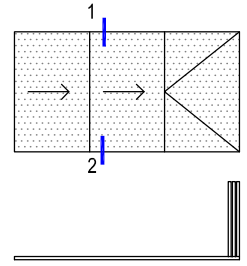
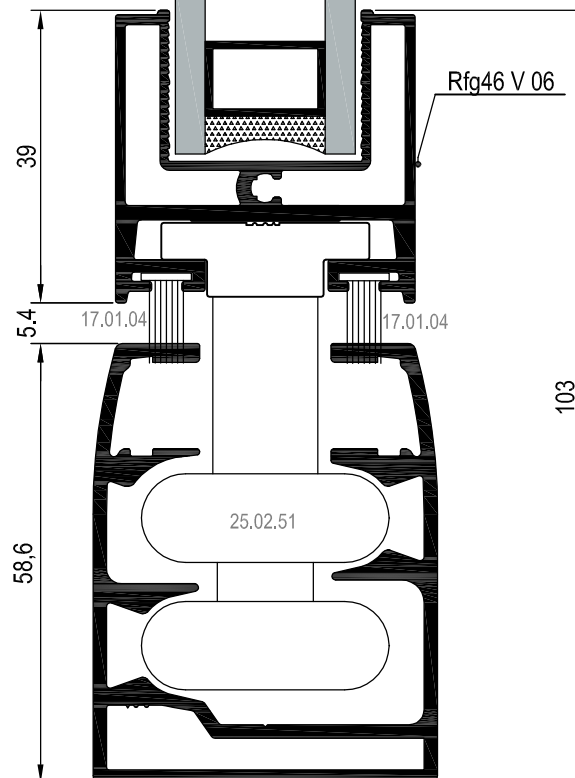

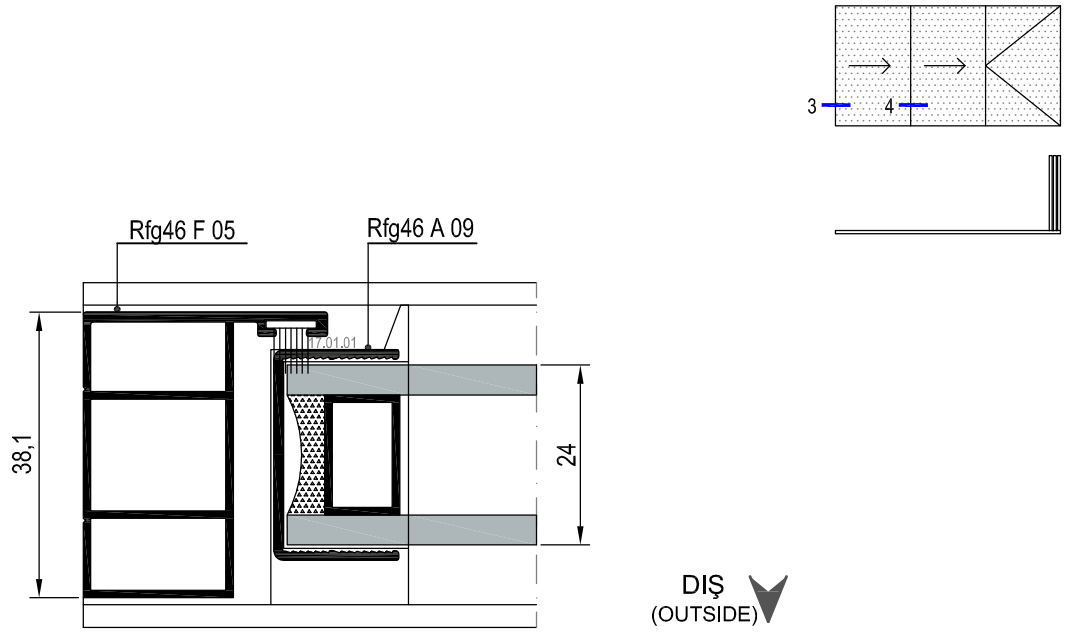

③ DETAYI
DETAIL

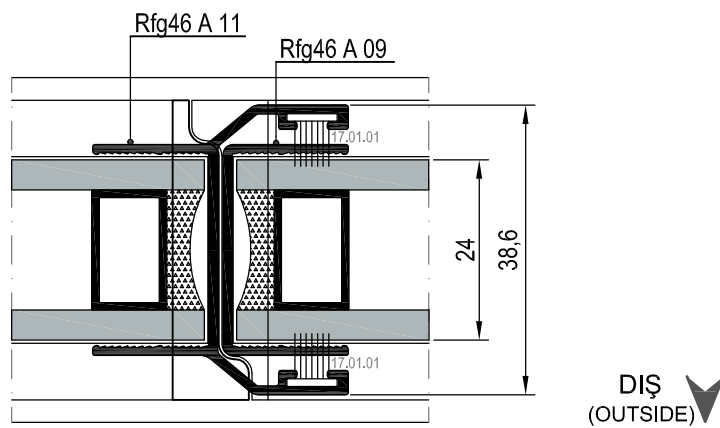

④ DETAYI
DETAIL

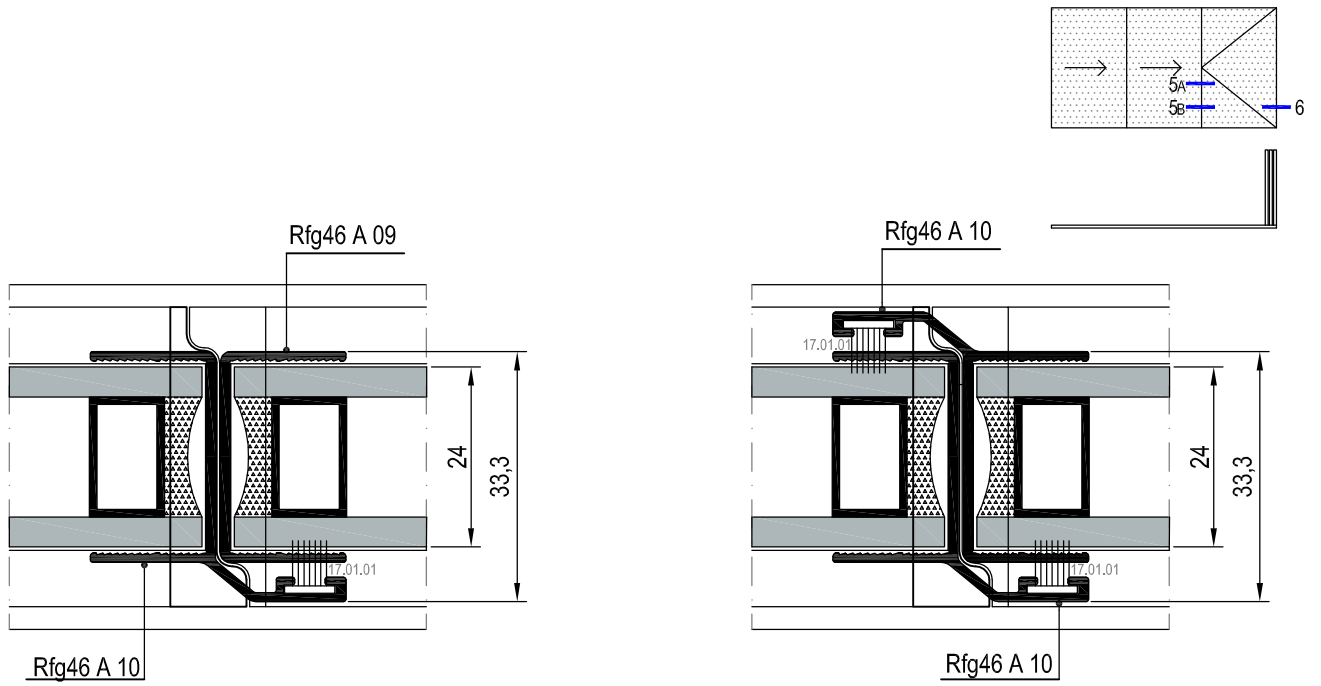

DIŞ
(OUTSIDE) ▼

⑤A DETAYI
DETAIL

⑤B DETAYI
DETAIL

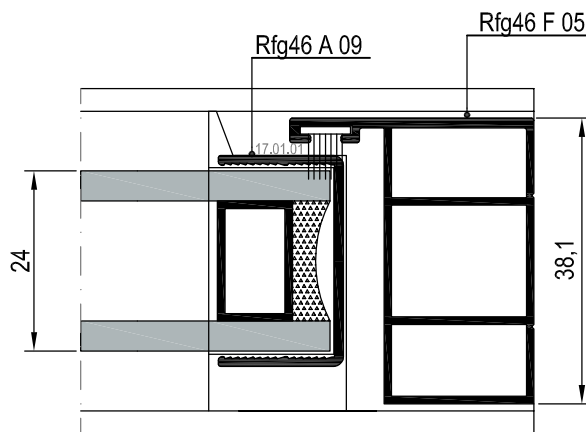

DIŞ
(OUTSIDE) ▼

⑥ DETAYI
DETAIL

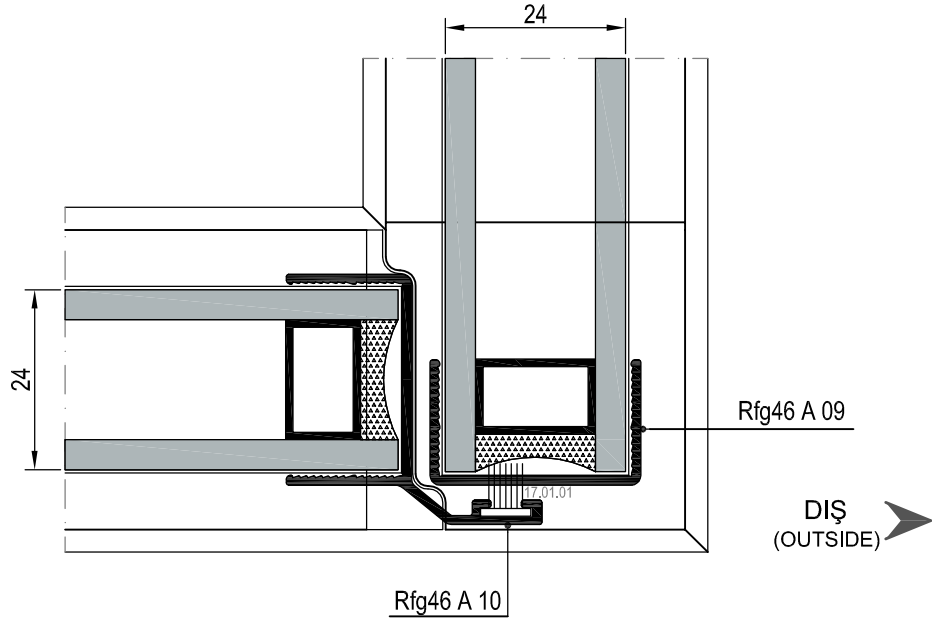
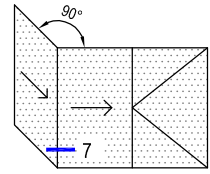

⑦ DETAYI
DETAIL

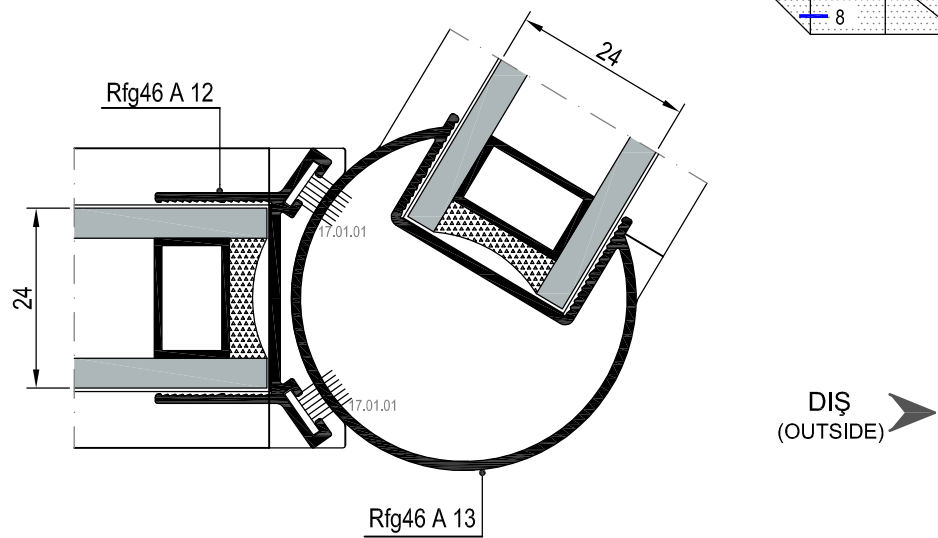
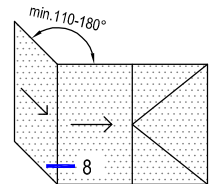

⑧ DETAYI
DETAIL

MİMARİ KATALOG
ARCHITECTURAL CATALOGUE

Alüminyum Kapı Pencere ve Giydirme Cephe Sistemleri
Aluminium Window Doors and Facade Systems











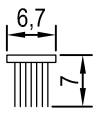
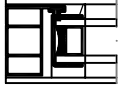

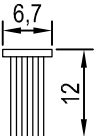
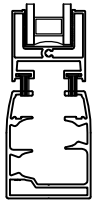

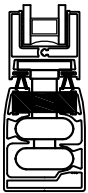

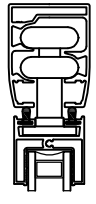

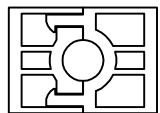

Rescara Sistem Detayları
Rescara System Details

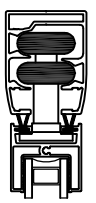
RF G46+

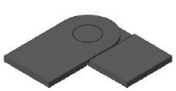
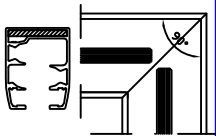
AKSESUARLAR

ACCESSORIES

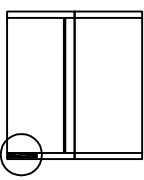
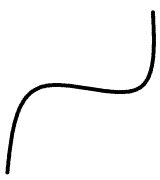
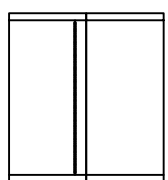
	<p>17.01.01</p> <p>KIL FİTİL 670X700 BRUSH 670X700</p> <p>Malzeme / Material Polipropilen / Polypropilene Paket / Package : 275 mt</p>			<p>25.02.33</p> <p>IP CHAIN</p>	
	<p>17.01.04</p> <p>KIL FİTİL 670X1200 BRUSH 670X700</p> <p>Malzeme / Material Polipropilen / Polypropilene Paket / Package : 275 mt</p>			<p>25.02.44</p> <p>FREN - ALT BRAKE (BOTTOM)</p> <p>Malzeme / Material: PVC-METAL BAĞLANTILI</p>	
	<p>17.03.04</p> <p>SÜNGER FİTİL Q-LON FOAM SEAL 69x950mm (25.02.37'nin muadildir.) (Equivalent product of 25.02.37)</p> <p>Paket / Package : 2'200mt</p>			<p>25.02.45</p> <p>FREN - ÜST BRAKE (UPPER)</p> <p>Malzeme / Material: PVC-METAL BAĞLANTILI</p>	
	<p>25.02.09</p> <p>KİLİTLİ TEKER ROLLER WITH LOCKER</p> <p>Malzeme / Material: PVC</p>			<p>25.02.46</p> <p>SABİT MENTEŞE FIX HINGE</p> <p>Malzeme / Material: PVC</p>	
	<p>25.02.10</p> <p>DÜZ TEKER SIMPLE ROLLER</p> <p>Malzeme / Material: PVC</p>			<p>ÖNERİLİR - RECOMMENDED</p> <p>25.02.50</p> <p>LÜKS KİLİTLİ METAL TEKER LUX ROLLER WITH LOCKER</p> <p>Malzeme / Material: Alüminyum Aluminium</p>	
	<p>25.02.17</p> <p>MAFSALLI GÖNYE CORNER BRACKET</p>			<p>ÖNERİLİR - RECOMMENDED</p> <p>25.02.51</p> <p>LÜKS DÜZ TEKER LUX SIMPLE ROLLER</p> <p>Malzeme / Material: Alüminyum Aluminium</p>	
	<p>25.02.31</p> <p>STOPLAMA VENT HOLDER</p> <p>Malzeme / Material: PVC</p>			<p>25.02.52</p> <p>ZİNCİR CHAIN</p>	

ZEMİN VE 1.KATLARDA KULLANILMALIDIR.MAKSİMUM DOĞRAMA YÜKSEKLİĞİ 1,6 M'DİR.

ZEMİN VE 1.KATLARDA KULLANILMALIDIR.MAKSİMUM DOĞRAMA YÜKSEKLİĞİ 1,6 M'DİR.

AKSESUARLAR
ACCESSORIES

RFG46+

	25.02.61 YAN KAPAK (Rfg46 F 01 ile) SIDE CAP (For Rfg46 F 01) Malzeme / Material: PVC			25.02.79 LÜKS KİLİT LUX LOCK Malzeme / Material: PVC (25.02.77 ve 78 ile) (With 25.02.77 and 78)	
	25.02.64 "T" STOPLAMA PARÇASI VENT HOLDER "T" PIECE			25.02.80 YAN KAPAK (Rfg46 F 03 ile) SIDE CAP (For Rfg46 F 03) Malzeme / Material: PVC	
	25.02.73 KROM KULP CROM HOLDER			25.02.82 3'LÜ FREN (PİMLE KULLANILIR) TRIPPLE BRAKE WITH PIN	
	25.02.75 FREN - ALT BRAKE (BOTTOM) Malzeme / Material: PVC-EKO			25.02.83 5'Lİ FREN (PİMLE KULLANILIR) BRAKE WITH PIN	
	25.02.76 FREN - ÜST BRAKE (UPPER) Malzeme / Material: PVC-EKO			25.02.84 7'Lİ FREN (PİMLE KULLANILIR) BRAKE WITH PIN	
	25.02.77 LÜKS ÇIKIŞ AĞZI LUX OUTLET CAP Malzeme / Material: PVC (25.02.78 ve 79 ile) (With 25.02.78 and 79)			25.02.85 8'Lİ FREN (PİMLE KULLANILIR) BRAKE WITH PIN	
	25.02.78 LÜKS BOYNUZ LUX HORN Malzeme / Material: PVC (25.02.77 ve 79 ile) (With 25.02.77 and 79)			25.02.86A PİMLİ FREN MENTEŞE (UZUN) BRAKE HINGE WITH PIN (LONG)	

	25.02.86B PİMLİ FREN MENTEŞE (KISA) BRAKE HINGE WITH PIN (SHORT)			25.02.93B ARA KAPAK(---) MIDDLE CAP (---) Malzeme / Material: PVC	
	25.02.87A SAĞ KISA BOYNUZ SHORT HORN (RIGHT) Max. Doğrama Ölçüsü Max. Window Dimension H:1200mm L:300 mm			25.02.94A BİTİŞ KAPAĞI (---) FINISH CAP (---) Malzeme / Material: PVC	
	25.02.87B SOL KISA BOYNUZ SHORT HORN (LEFT) Max. Doğrama Ölçüsü Max. Window Dimension H:1200mm L:300 mm			25.02.94B BİTİŞ KAPAĞI (---) FINISH CAP (---) Malzeme / Material: PVC-EKO	
	25.02.88 ALT 8'Lİ FREN BRAKE BOTTOM			25.02.95A AÇILI KAPAK (SOL) ANGLED CAP (LEFT) Malzeme / Material: PVC	
	25.02.89 ÜST 8'Lİ FREN BRAKE UPPER			25.02.95B AÇILI KAPAK (SAĞ) ANGLED CAP (RIGHT) Malzeme / Material: PVC	
	25.02.91 STOPLAMA STOPER			25.02.96A KÖŞE KAPAK (ALT) CORNER CAP (DOWN) Malzeme / Material: PVC	
	25.02.93A ARA KAPAK(---) MIDDLE CAP(---) Malzeme / Material: PVC			25.02.96B KÖŞE KAPAK (ÜST) CORNER CAP (UPPER) Malzeme / Material: PVC	

MİMARİ KATALOG
ARCHITECTURAL CATALOGUE

Alüminyum Kapı Pencere ve Giydirme Cephe Sistemleri
Aluminium Window Doors and Facade Systems



Rescara Sistem Detayları
Rescara System Details





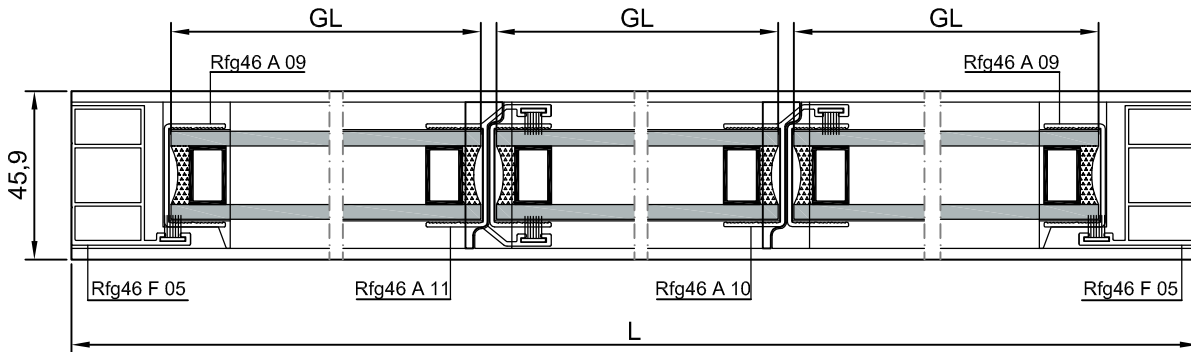
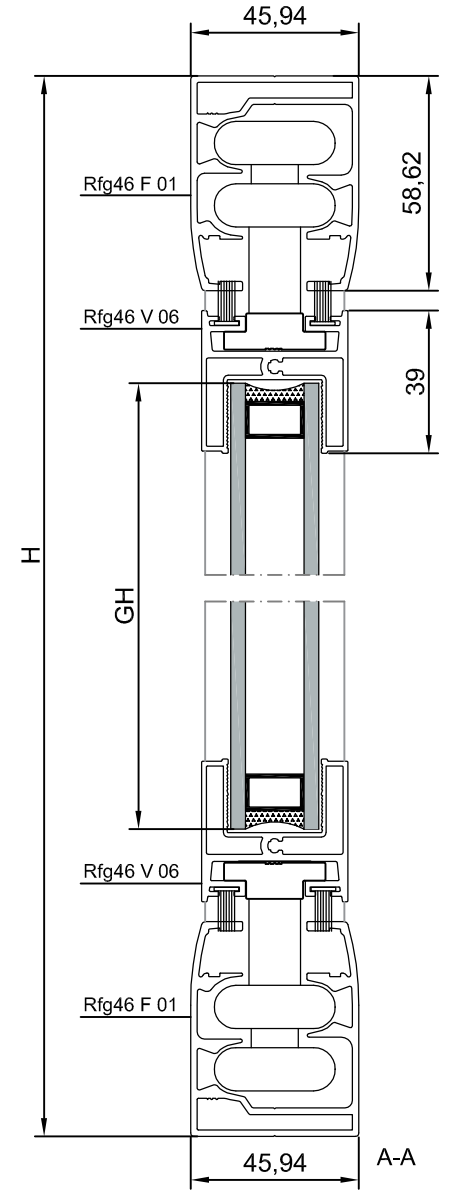
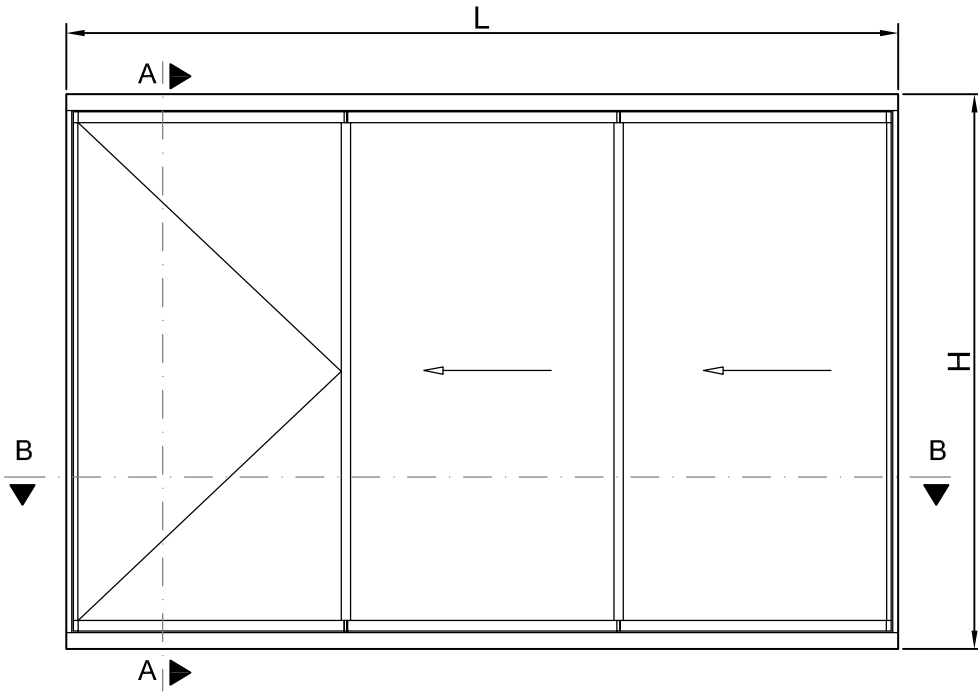







RF G46+

İMALAT DETAYLARI
FABRICATION DETAILS



B-B
ÖLÇEK:1/2

PROFİLLER / Profiles





KOD code	PROFİL profile		ADET unit	KESİM ÖLÇÜSÜ Cutting Dimension
RFG46 F 01	A 		2	L
RFG46 F 05	B 		2	H - 27,2
RFG46 V 06	V 		4	GL - 20,2
			2	GL - 8,6
RFG46 A 09	T 		4	H - 206
RFG46 A 11			1	H - 206
RFG46 A 10			1	H - 206
CAM /Glass			GL	$\frac{L - 54,4 - ((n-1) \cdot 4,3)}{n}$
			GH	H - 167,8

(n = Kanat adedi)

FİTİLLER/ Gaskets

	17.01.01	Kıl Fıtil	$(n+1)(H-206)$
	17.01.04	Kıl Fıtil	12GL-196,8

YAN KAPAKLI-ALTERNATİF KESİM ÖLÇÜSÜ

KOD code	PROFİL profile		ADET unit	KESİM ÖLÇÜSÜ Cutting Dimension
RFG46 F 01	A 		2	L-3
RFG46 F 05	B 		2	H - 117,2





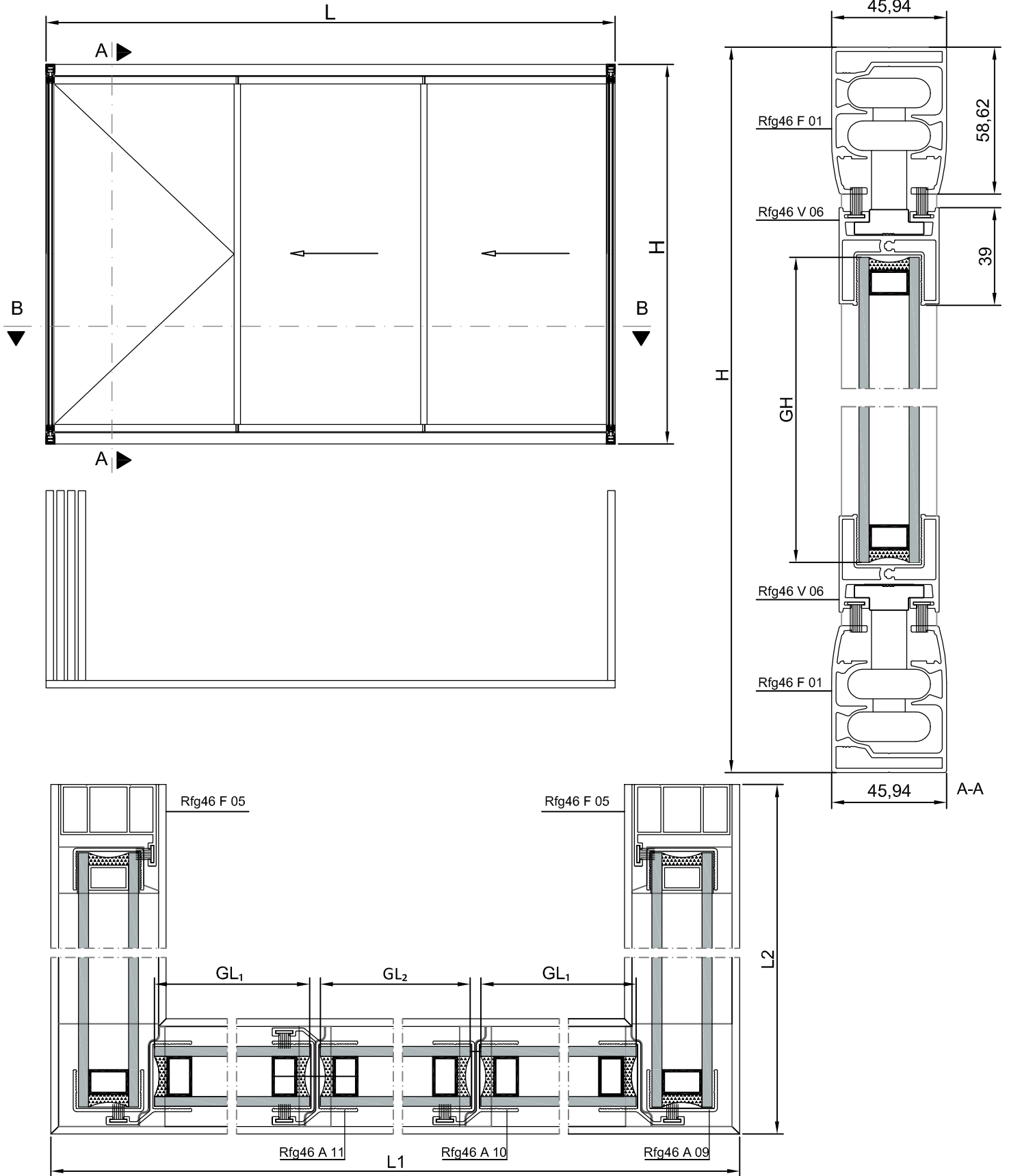

AKSESUARLAR/ Accessories

AKSESUAR Accessory	KOD code	AÇIKLAMA description	ADET unit
	25.02.93A	Kanat Arka Kapağı	4
	25.02.93B	Kanat Arka Kapağı	4
	25.02.94A	Bitiş Kapağı	2
	25.02.94B	Bitiş Kapağı	2
	25.02.09	Kilitli Teker	4
	25.02.10	Düz Teker	6
	25.02.77	Lüks Çıkış Ağzı	2
	25.02.78	Lüks Boynuz	1
	25.02.79	Lüks Kilit	2
	25.02.75	Fren - Alt	1
	25.02.76	Fren - Üst	1
	25.02.61	Yan Kapak	4



B-B
ÖLÇEK:1/2



U TİP ISICAMLI CAM BALKON
PROFİLLER / Profiles

KOD code	PROFİL profile	ADET unit	KESİM ÖLÇÜSÜ Cutting Dimension
RFG46 F 01	A 	2	L1
RFG46 F 01	A1 	2n ₁	L2
RFG46 F 05	B 	2	H - 27,2
RFG46 V 06	V 	2n ₁	V1=(L2-87,3)
		2n ₃	V2= $\frac{L-91-(n_3-1)12,7}{n_3}$
RFG46 A 09	T 	n ₂ +1	H - 206
RFG46 A 11		n ₃ - 2	H - 206
RFG46 A 10		3	H - 206



n₂=Toplam Kanat Adedi
n₁=Köşe Adedi
n₂=Köşe Birleşim Kanat adedi
n₃=Alındaki Kanat Adedi

CAM /Glass	n ₁	GL ₁ =L2-37,9
	n ₃	GL ₂ = $\frac{L-82,6-(n_3-1)4,3}{n_3}$
	n ₂	GH = H - 167,8

FİTİLLER/ Gaskets

	17.01.01	Kıl Fitil	(n ₂ +1).(H-206)
	17.01.04	Kıl Fitil	4L1+(4n ₁ .L2)

YAN KAPAKLI-ALTERNATİF KESİM ÖLÇÜSÜ

KOD code	PROFİL profile	ADET unit	KESİM ÖLÇÜSÜ Cutting Dimension
RFG46 F 01	A 	2	L2-1,5
RFG46 F 05	B 	2	H - 117,2

AKSESUARLAR/ Accessories

AKSESUAR Accessory	KOD code	AÇIKLAMA description	ADET unit
	25.02.93A	Kanat Arka Kapağı	2n ₃
	25.02.93B	Kanat Arka Kapağı	2n ₃
	25.02.96A	Köşe Kapak (Alt)	n ₁
	25.02.96B	Köşe Kapak (Üst)	n ₁
	25.02.09	Kilitli Teker	2n ₃ -2
	25.02.10	Düz Teker	2n ₃ +8
	25.02.77	Lüks Çıkış Ağızı	2
	25.02.78	Lüks Boyunz	1
	25.02.79	Lüks Kilit	2
	25.02.75	Fren - Alt	1
	25.02.76	Fren - Üst	1
	25.02.61	Yan Kapak	4

şema1

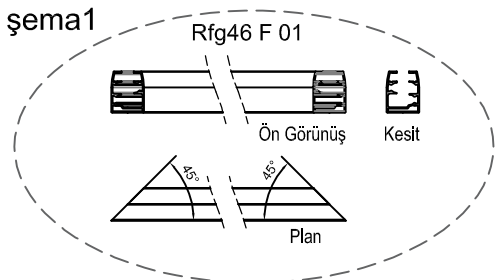

şema2

