

MİMARİ KATALOG ARCHITECTURAL CATALOGUE

Alüminyum Kapı Pencere ve Giydirme Cephe Sistemleri
Aluminium Window Doors and Facade Systems

RESCARA

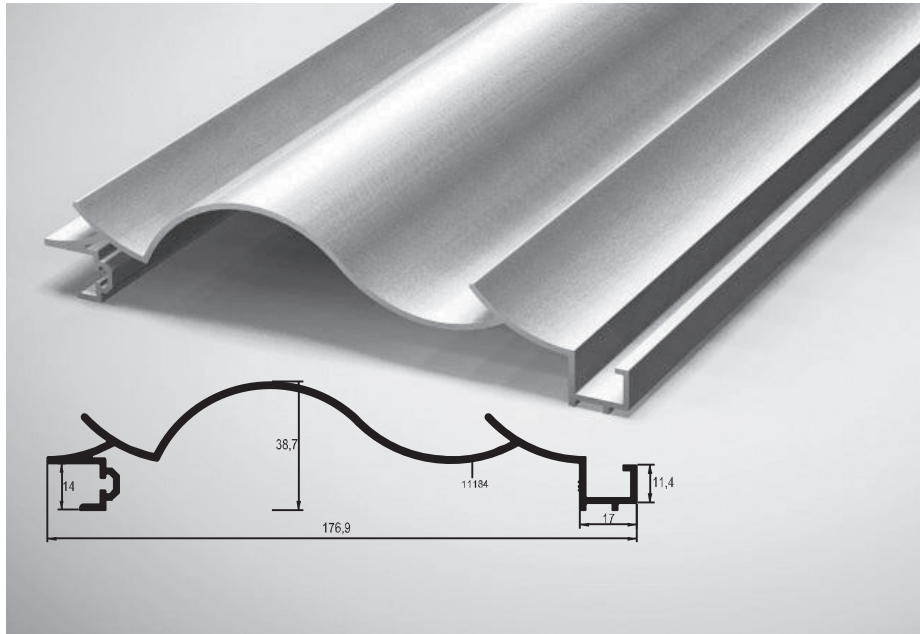

RDP

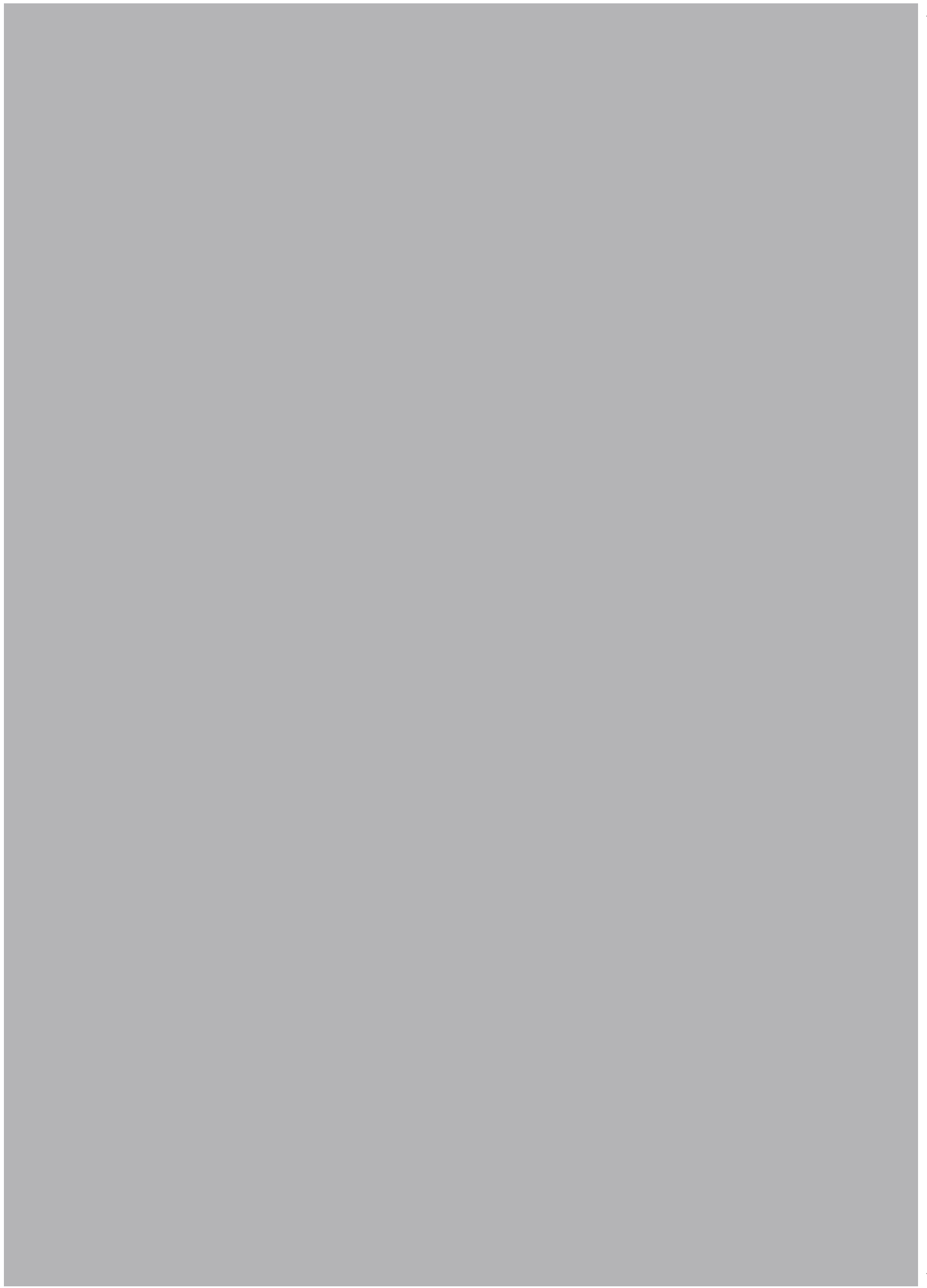

MİMARİ KATALOG ARCHITECTURAL CATALOGUE

Alüminyum Kapı Pencere ve Giydirme Cephe Sistemleri
Aluminium Window Doors and Facade Systems



Rescara Sistem Detayları
Rescara System Details

RDP

PROFİLLER

PROFILES

01

02

03

04

05

06

07

08

09

10

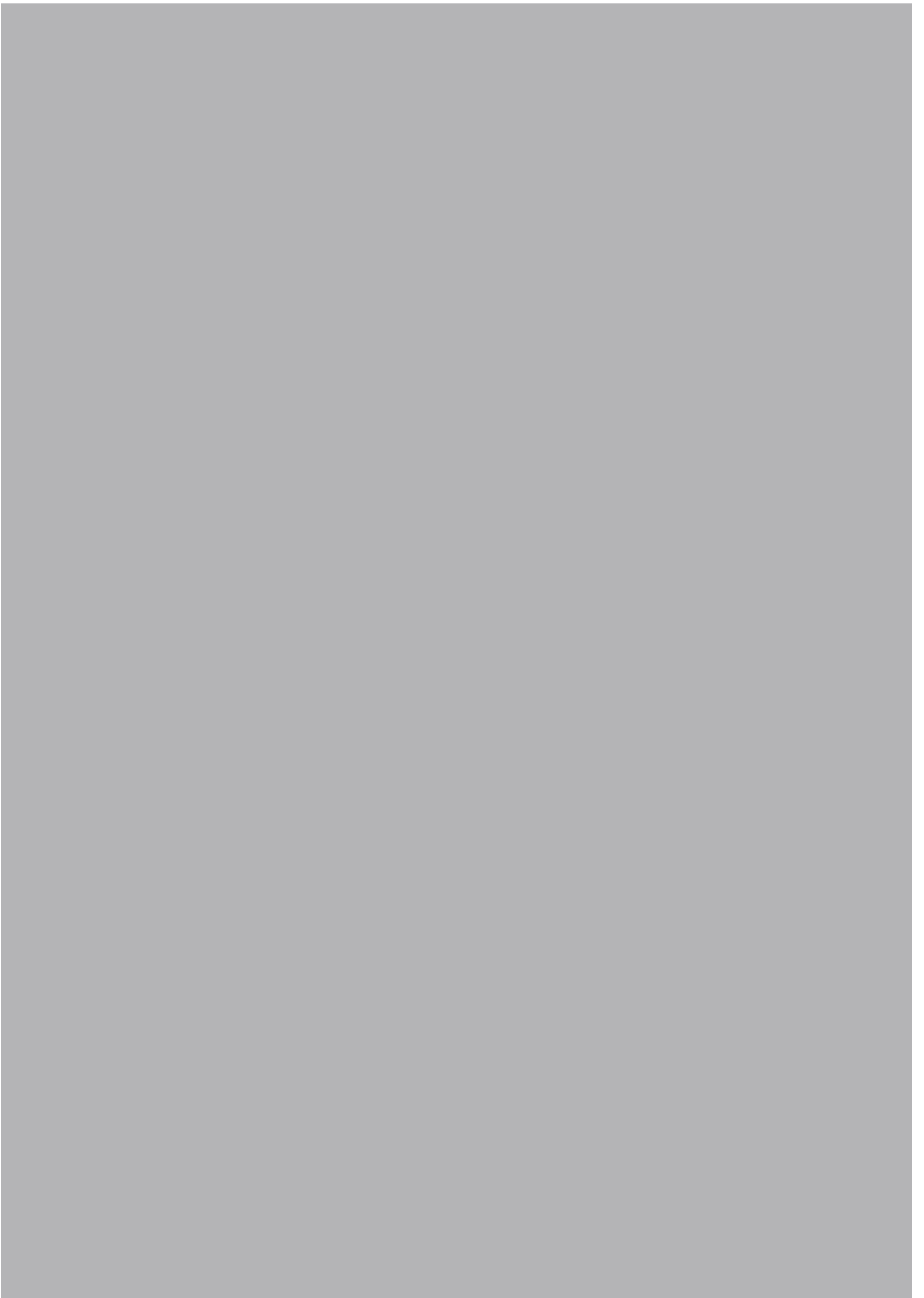

YATAY PROFİLLER
TRANSOM PROFILES

RDP

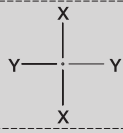
KOD / CODE	AĞIRLIK (kg/m) / WEIGHT	L m	
DP 01	1,369	6	
DP 05	1,344	6	

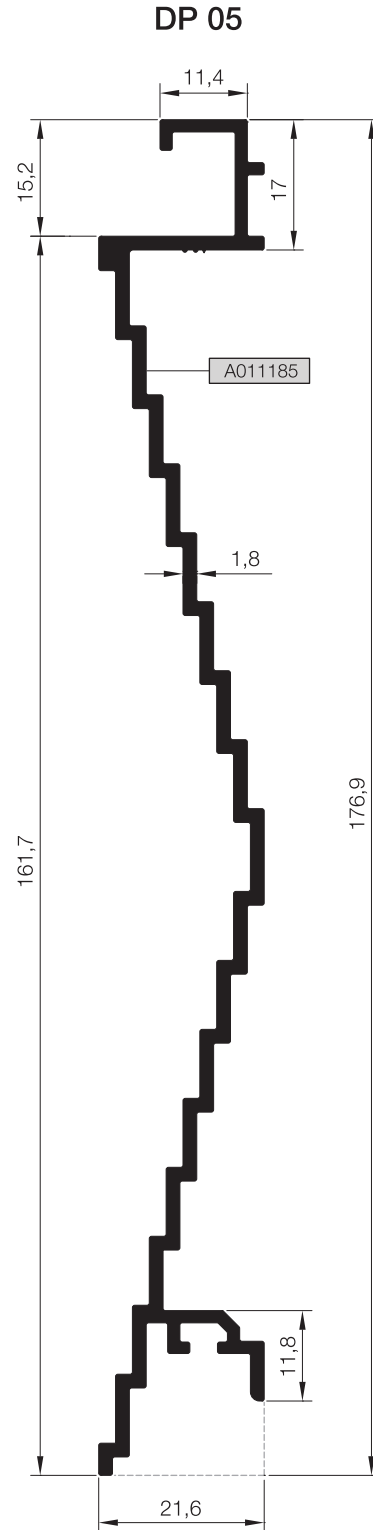
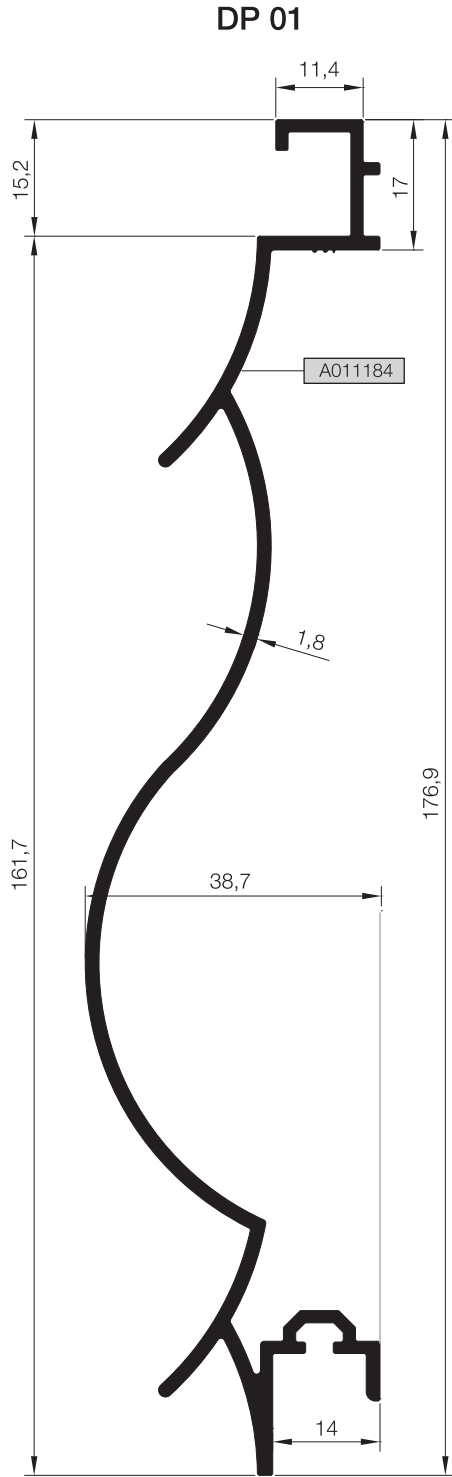

01

02

03

04

05

06

07

08

09

10

YATAY PROFİLLER
TRANSOM PROFILES

RDP

KOD / CODE	AĞIRLIK (kg/m) / WEIGHT	L m	
DP 06	1,218	6	
DP 07	1,193	6	

01

02

03

04

05

06

07

08

09

10

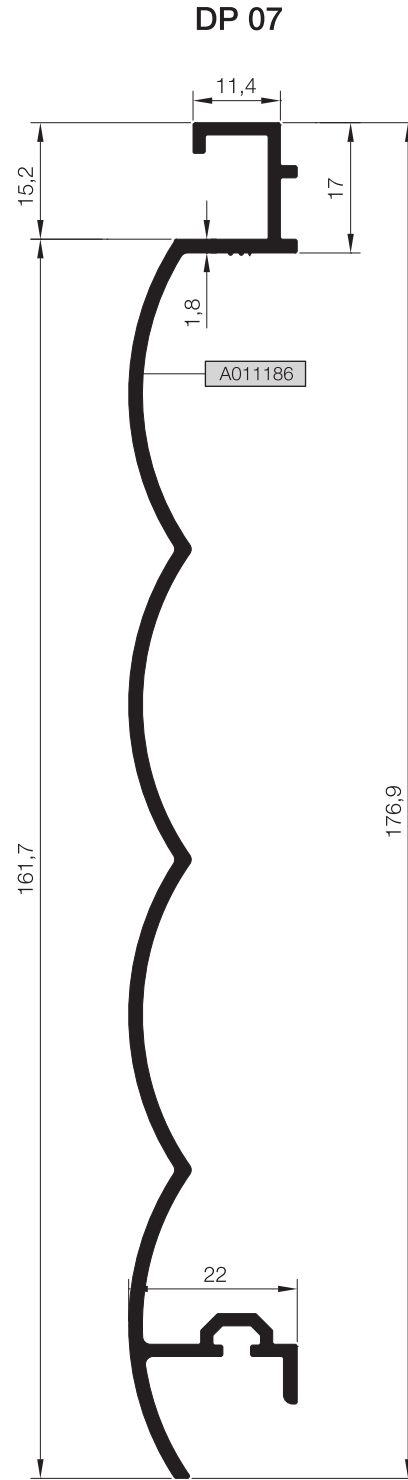
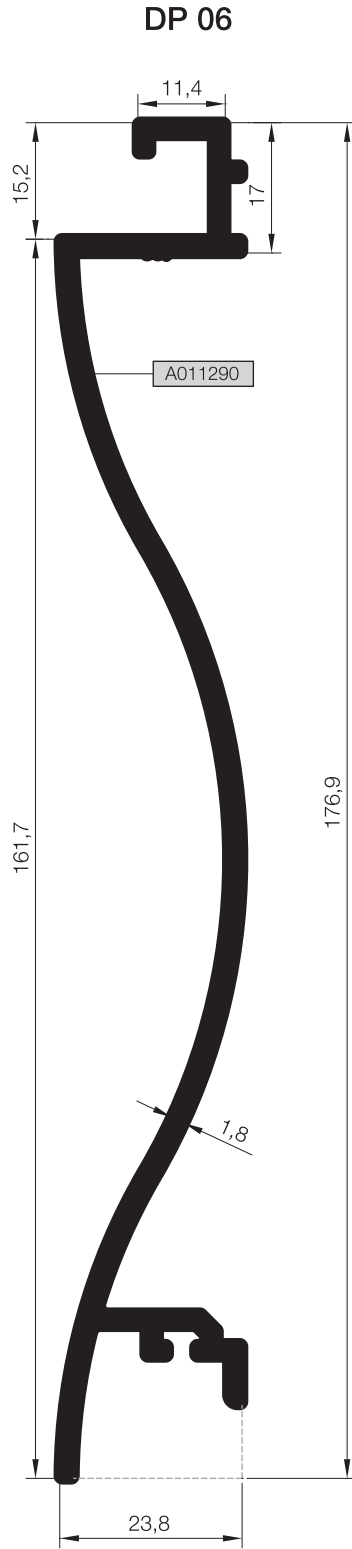

YATAY PROFİLLER
TRANSOM PROFILES

RDP

KOD / CODE	AĞIRLIK (kg/m) / WEIGHT	L m	
DP 10	1,253	6	
DP 11	1,172	6	

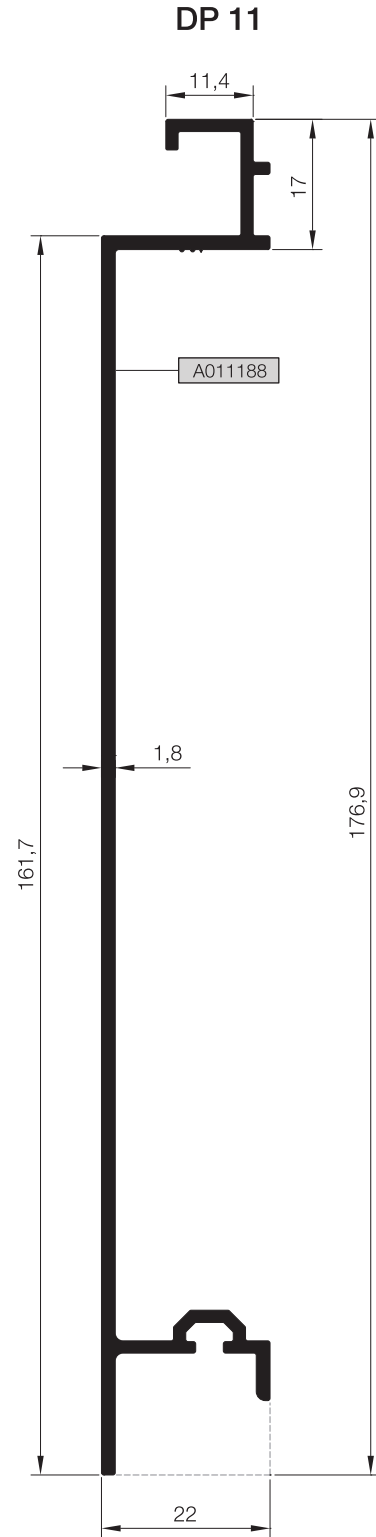
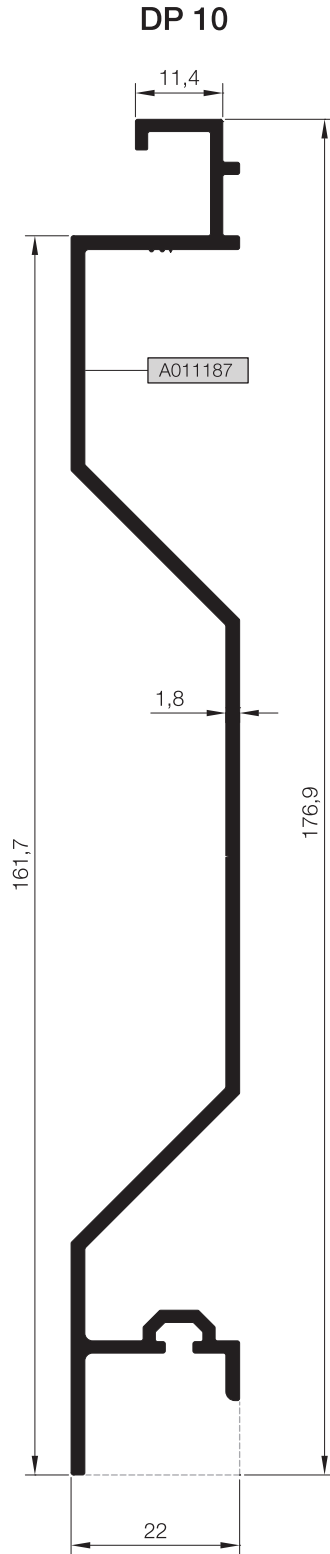

01

02

03

04

05

06

07

08

09

10

ANKRAJ VE ADAPTÖR PROFİLLERİ
ANCHORAGE AND ADAPTER PROFILES

RDP

KOD / CODE	AĞIRLIK (kg/m) / WEIGHT	Jxx cm ⁴	Jyy cm ⁴	L m
A011182	0,665	7,703	5,479	6
A011183	0,955	----	----	6
DP 13	0,141	----	----	6

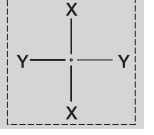

01

02

03

04

05

06

07

08

09

10

A011182

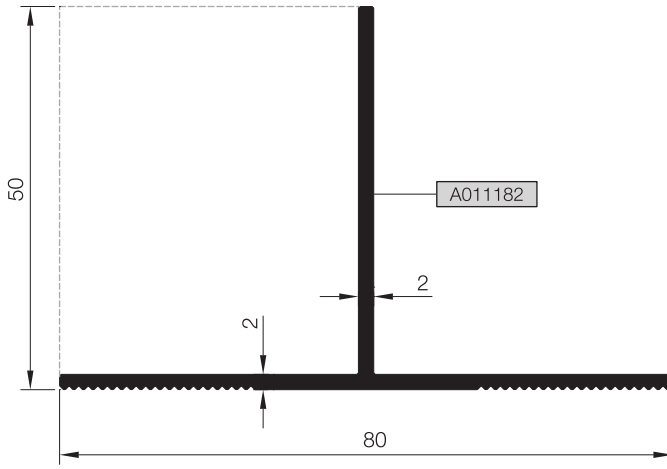

A011183

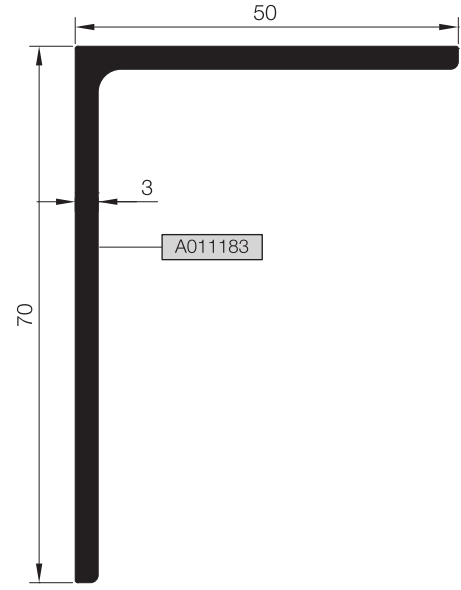

DP 13

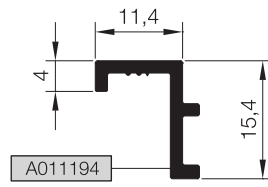

MİMARİ KATALOG ARCHITECTURAL CATALOGUE

Alüminyum Kapı Pencere ve Giydirme Cephe Sistemleri
Aluminium Window Doors and Facade Systems



Rescara Sistem Detayları
Rescara System Details

RDP

DETAYLAR

DETAILS

01

02

03

04

05

06

07

08

09

10

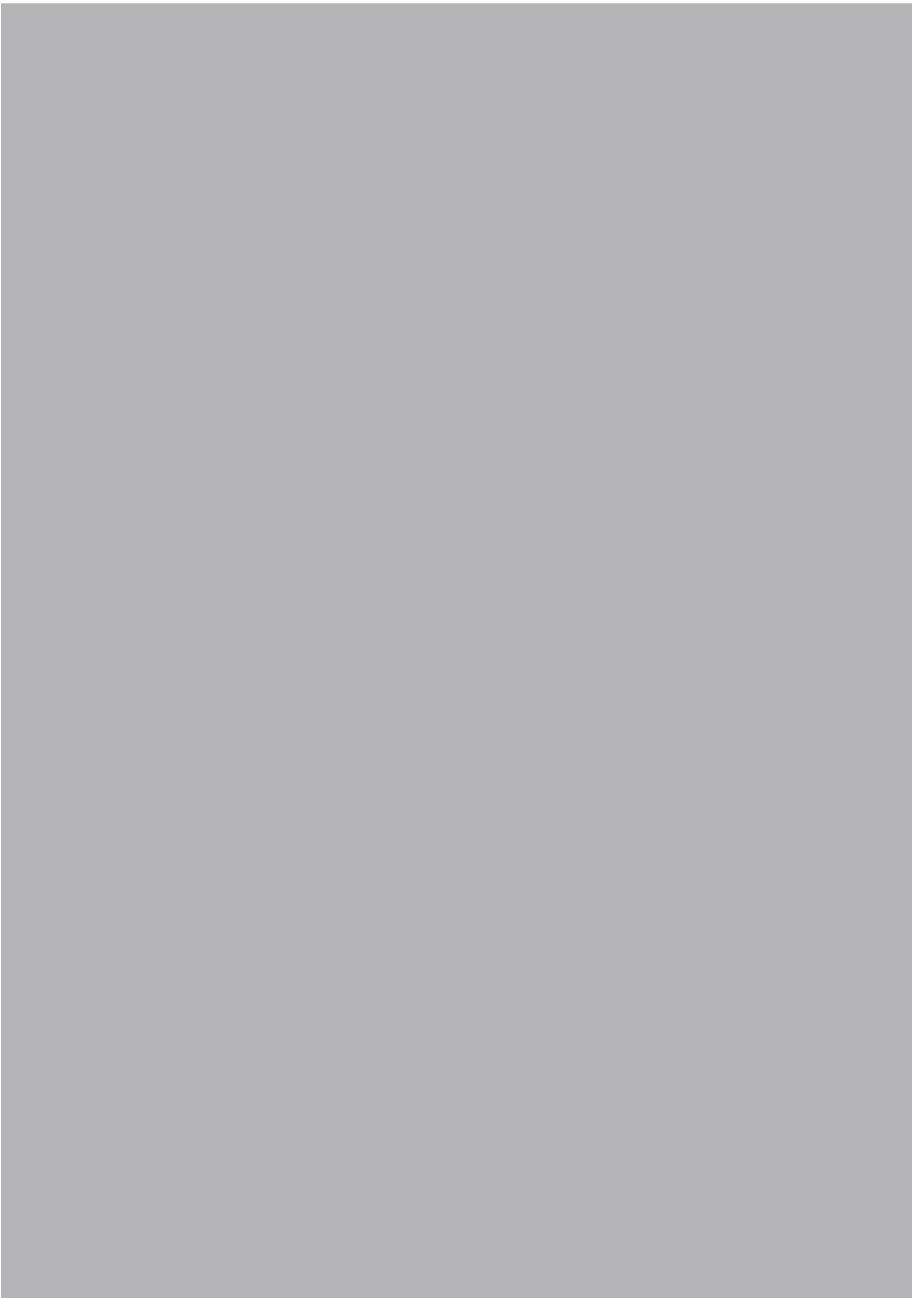

01

02

03

04

05

06

07

08

09

10

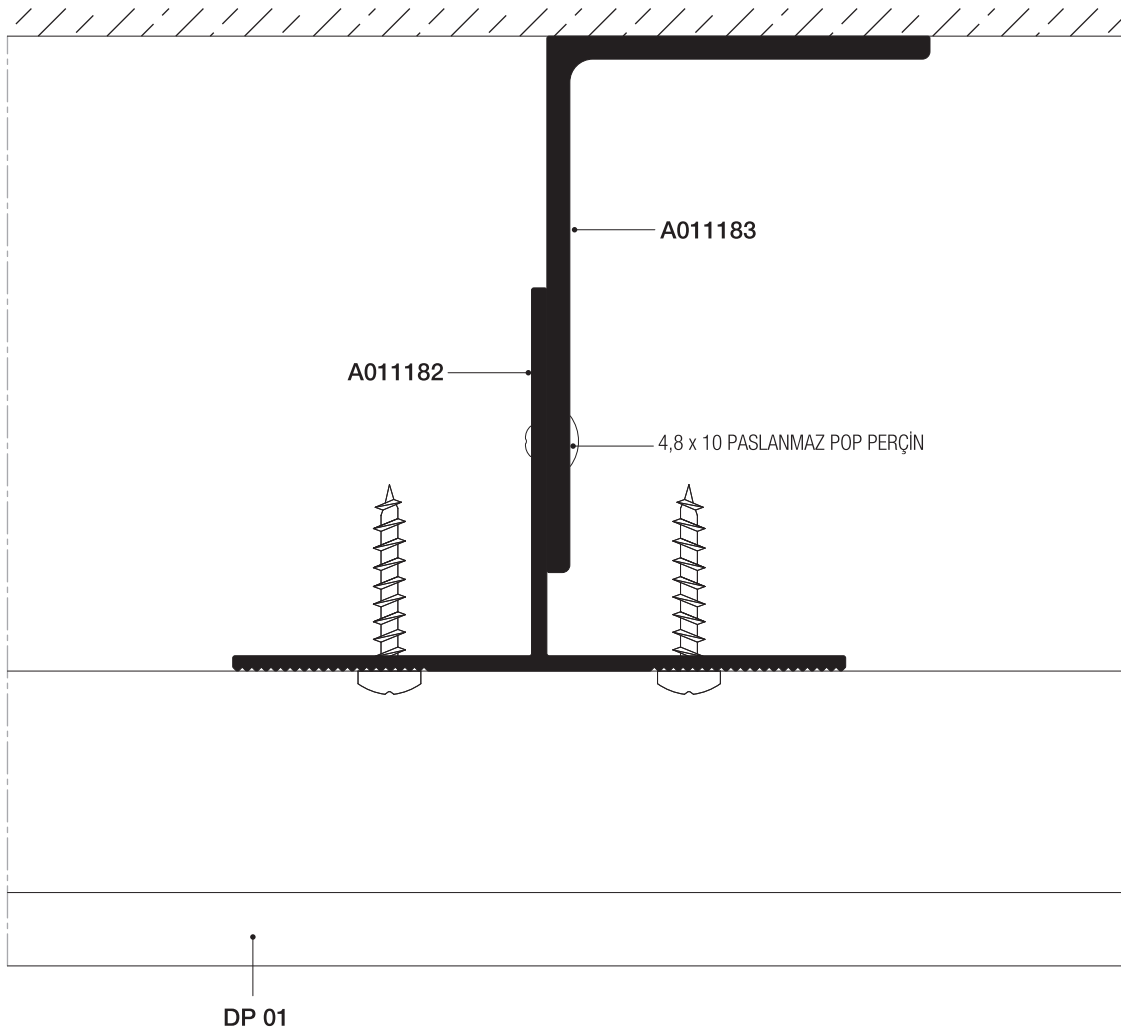

01

02

03

04

05

06

07

08

09

10

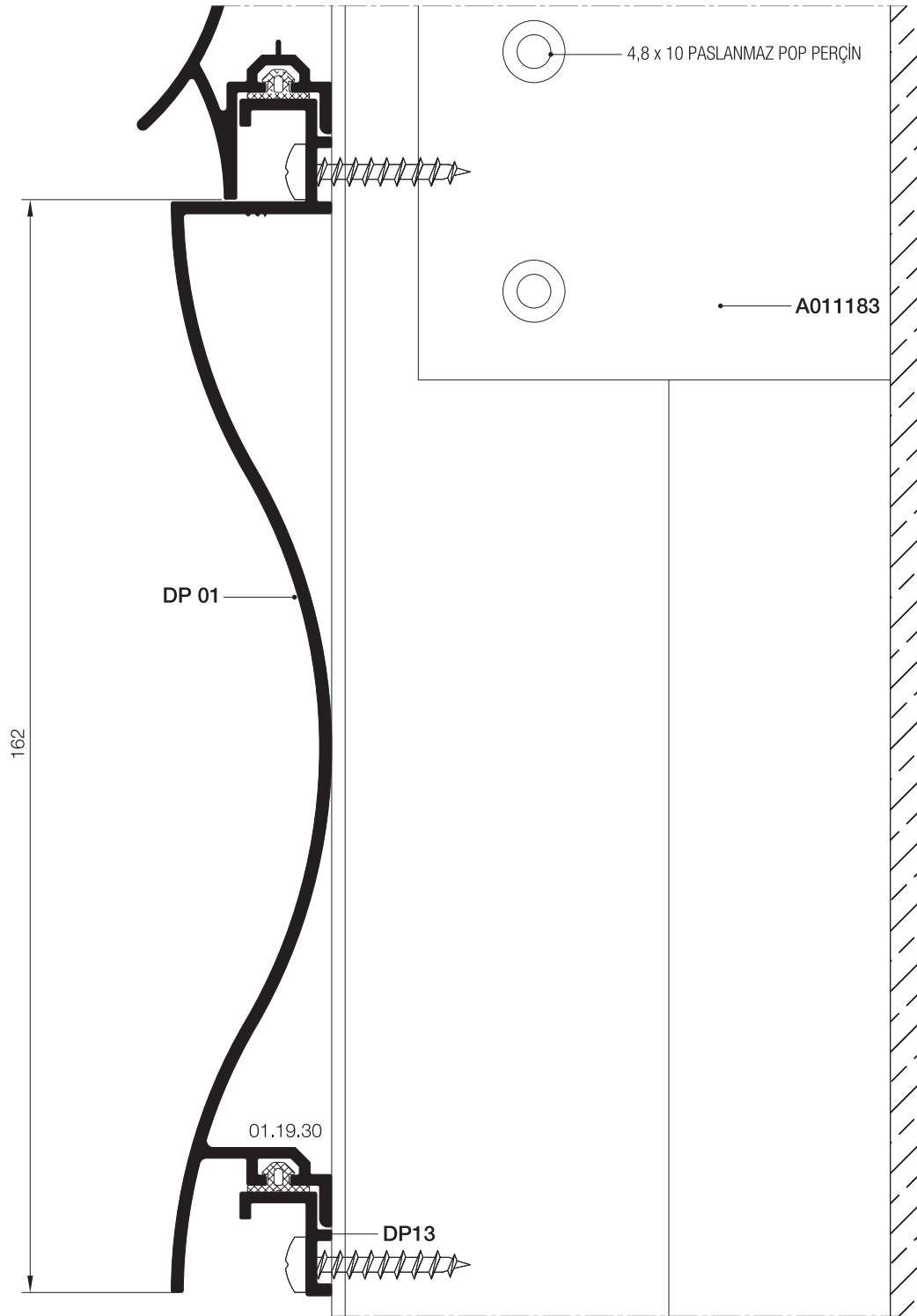

MİMARİ KATALOG ARCHITECTURAL CATALOGUE

Alüminyum Kapı Pencere ve Giydirme Cephe Sistemleri
Aluminium Window Doors and Facade Systems



Rescara Sistem Detayları
Rescara System Details

RDP

AKSESUARLAR

ACCESSORIES

01

02

03

04

05

06

07

08

09

10

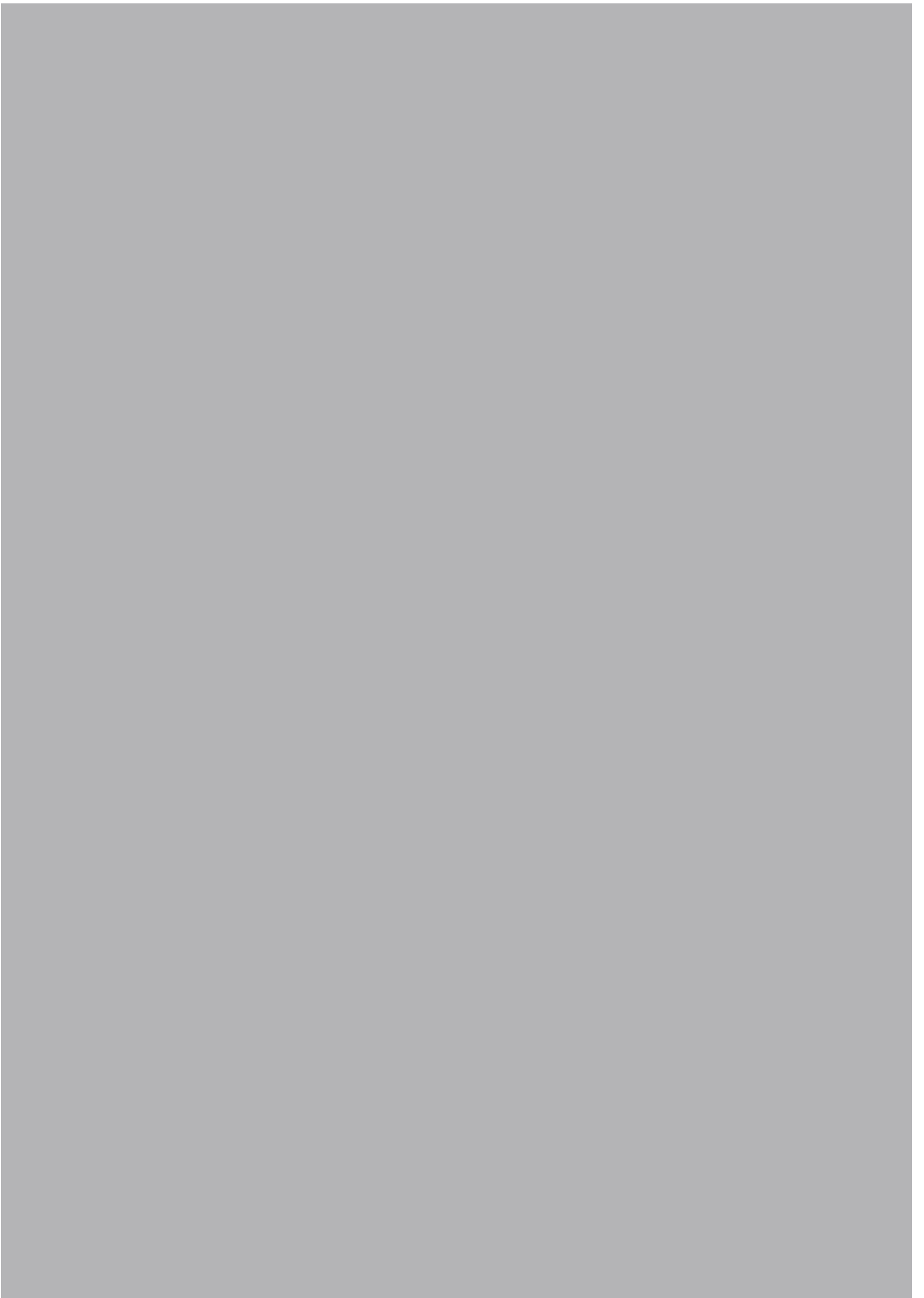

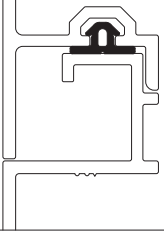
	01.19.30 Bini FİTİLİ GASKET Malzeme / Material : EPDM Ağırlık / Weight : 26 gr/m Paket / Package : 576,9 m / 15 kg				

01

02

03

04

05

06

07

08

09

10

