

MİMARİ KATALOG
ARCHITECTURAL CATALOGUE

Alüminyum Kapı Pencere ve Giydirme Cephe Sistemleri
Aluminium Window Doors and Facade Systems

RESCARA

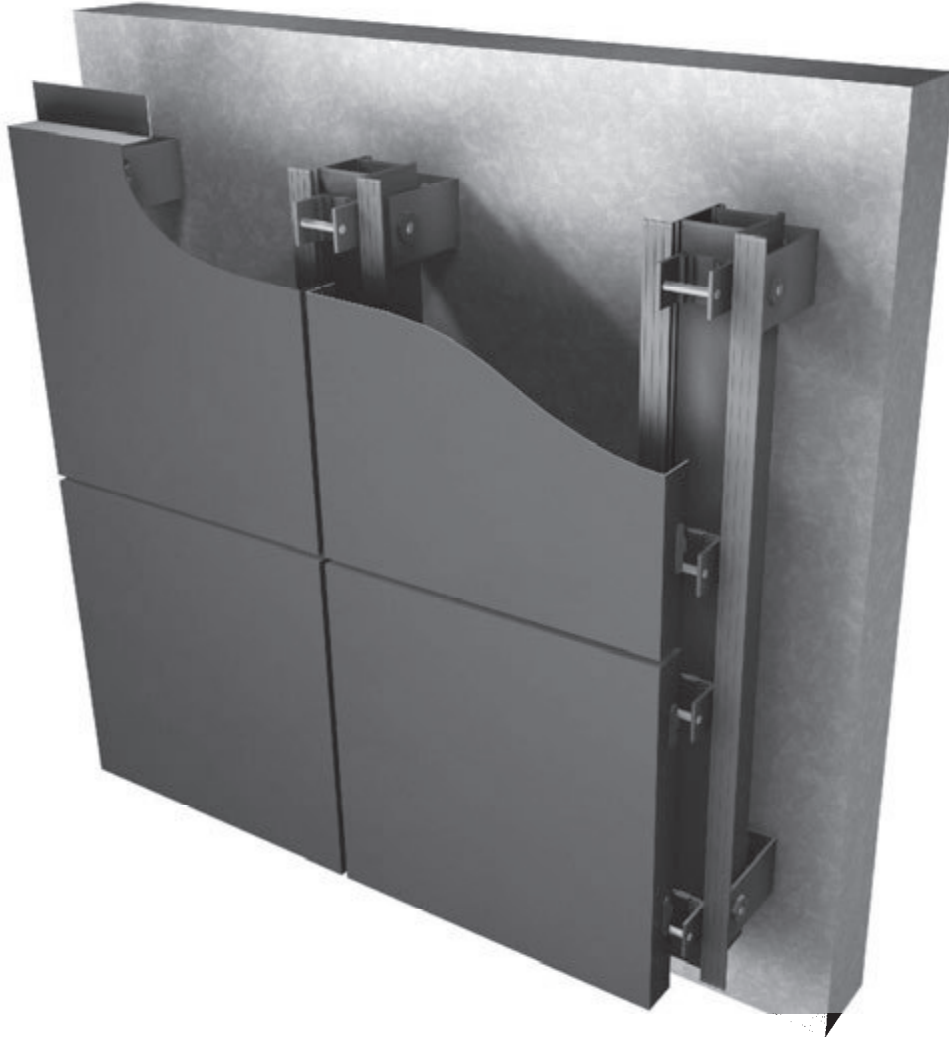

Rtc22

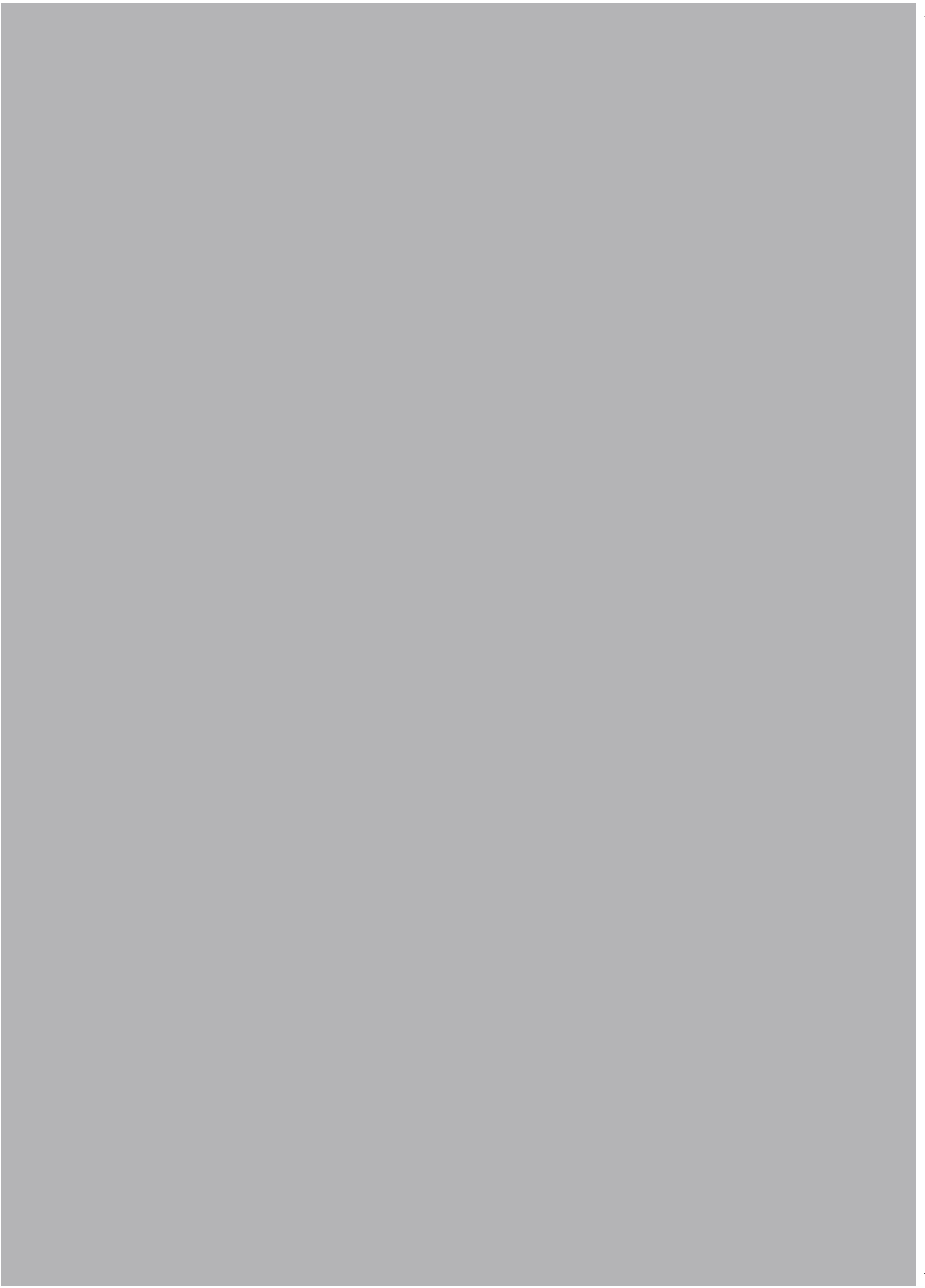

MİMARİ KATALOG ARCHITECTURAL CATALOGUE

Alüminyum Kapı Pencere ve Giydirme Cephe Sistemleri
Aluminium Window Doors and Facade Systems



Rescara Sistem Detayları
Rescara System Details

Rtc22

PROFİLLER

PROFILES

01

02

03

04

05

06

07

08

09

10

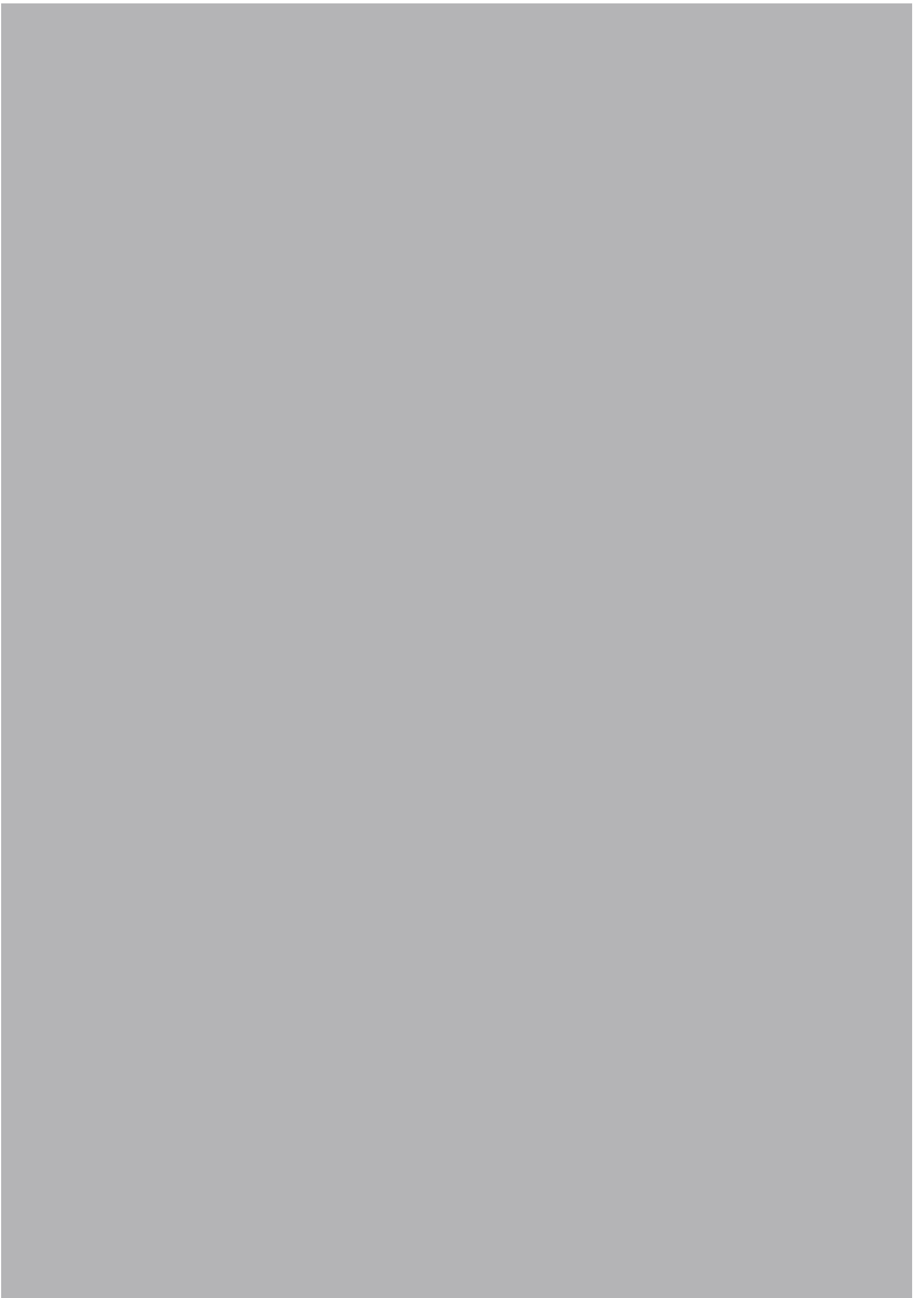

DÜŞEY PROFİLLER
MULLION PROFILES

Rtc22

KOD / CODE	AĞIRLIK (kg/m) / WEIGHT	Jxx cm4	Jyy cm4	L m	
TC22 M 01	0,813	12,260	2,771	6	
TC22 M 02	0,718	11,938	1,507	6	
TC22 M 05	0,663	9,328	2,495	6	
TC22 M 06	0,216	0,406	0,304	6	
TC22 M 07	0,278	0,503	0,338	6	

TC22 M 01

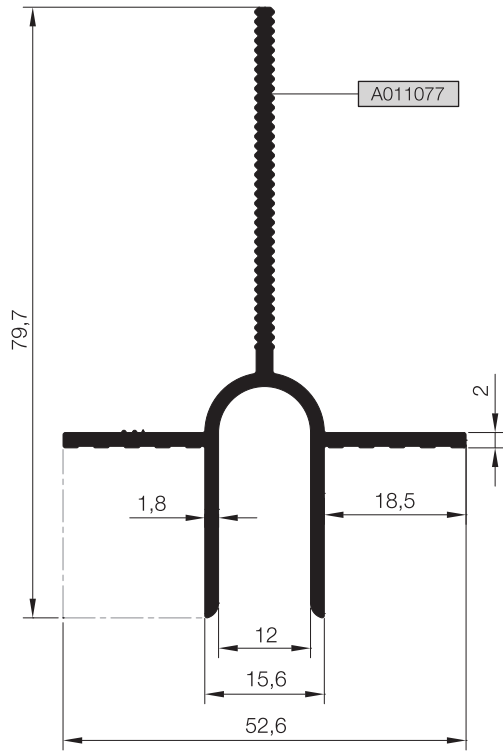

TC22 M 02

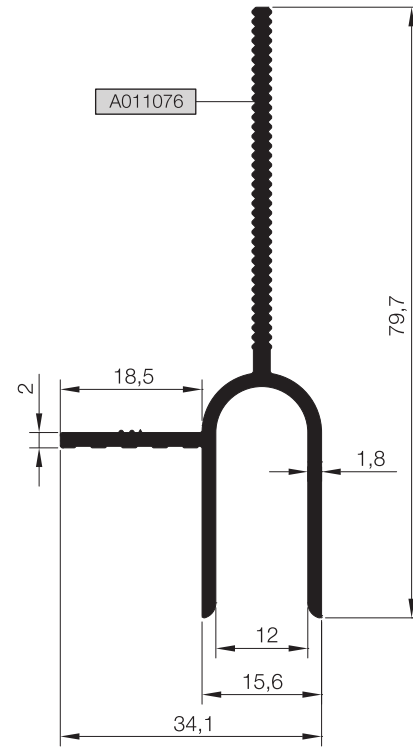

TC22 M 05

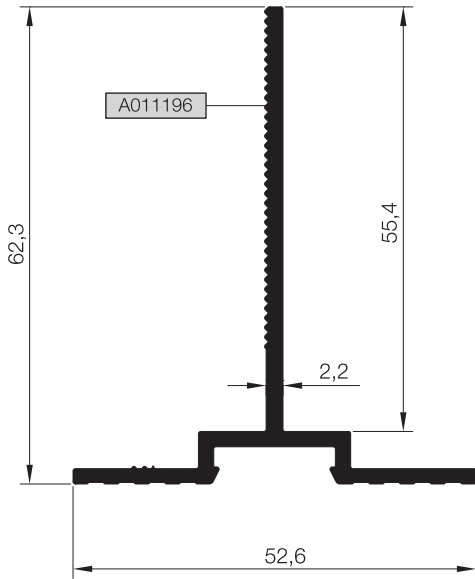

TC22 M 06

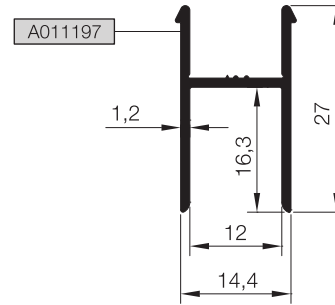

TC22 M 07

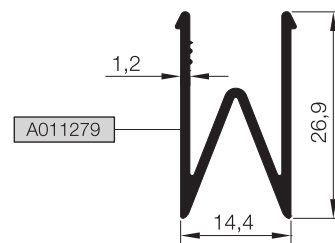

01

02

03

04

05

06

07

08

09

10

DÜŞEY PROFİLLER
MULLION PROFILES

Rtc22

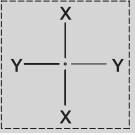
KOD / CODE	AĞIRLIK (kg/m) / WEIGHT	Jxx cm ⁴	Jyy cm ⁴	L m	
TC22 M 03	1,225	44,280	6,512	6	
TC22 M 04	0,409	1,650	1,006	6	

01

02

03

04

05

06

07

08

09

10

TC22 M 03

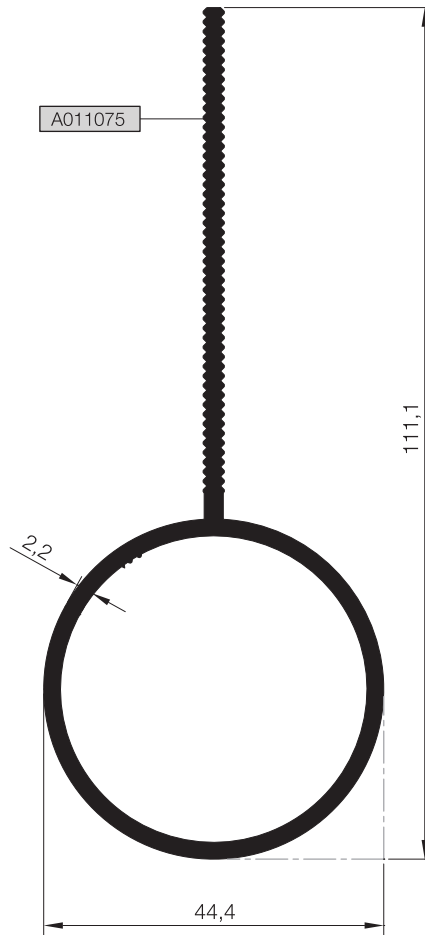

TC22 M 04

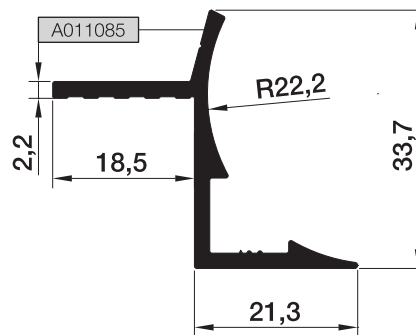

YATAY PROFİLLER
TRANSOM PROFILES

Rtc22

KOD / CODE	AĞIRLIK (kg/m) / WEIGHT	Jxx cm4	Jyy cm4	L m	
TC22 T 01	1,175	2,406	153,600	6	
TC22 T 02	1,780	3,196	507,850	6	

TC22 T 01

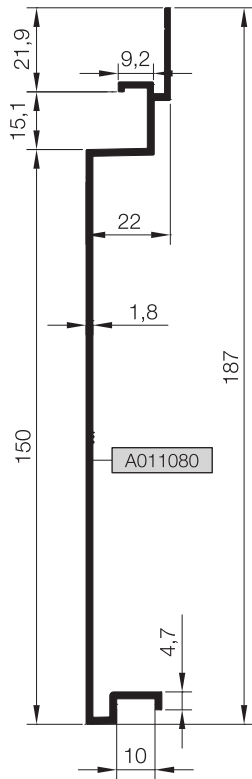

TC22 T 02

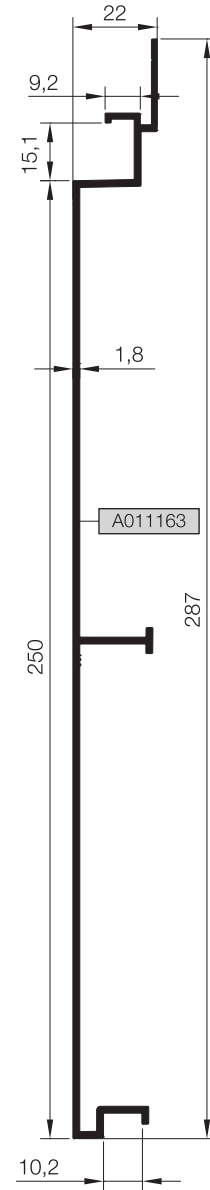

01

02

03

04

05

06

07

08

09

10

ÖLÇEK : 1/2
SCALE : 1/2

ADAPTÖR PROFİLLERİ
ADAPTER PROFILES

Rtc22

KOD / CODE	AĞIRLIK (kg/m) / WEIGHT	L m	
TC22 A 01	0,231	6	
TC22 A 02	0,194	6	
TC22 A 03	0,339	6	
TC22 A 04	0,200	6	

01

02

03

04

05

06

07

08

09

10

TC22 A 01

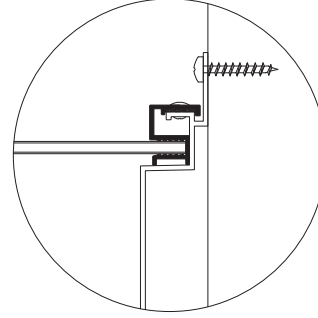
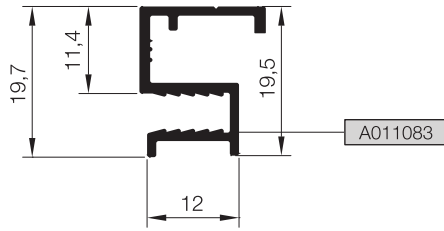

TC22 A 02

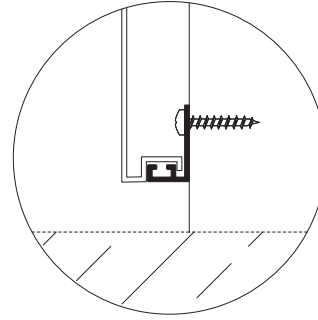
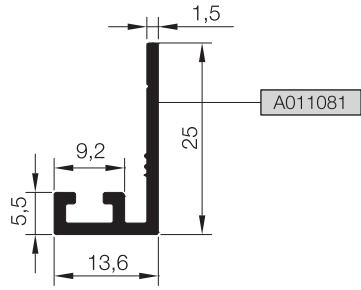

TC22 A 03

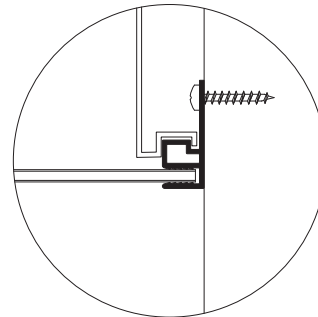
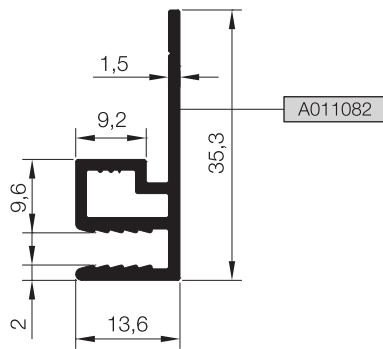

TC22 A 04

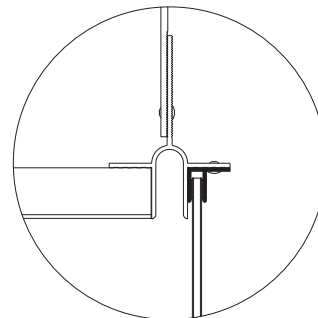
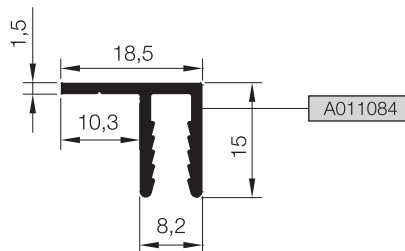

ANKRAJ PROFİLLERİ
ANCHORAGE PROFILES

Rtc22

KOD / CODE	AĞIRLIK (kg/m) / WEIGHT	Jxx cm ⁴	Jyy cm ⁴	L m	
TC22 C 01	0,750	12,327	2,651	6	
TC22 C 02	0,919	35,515	1,511	6	

TC22 C 01

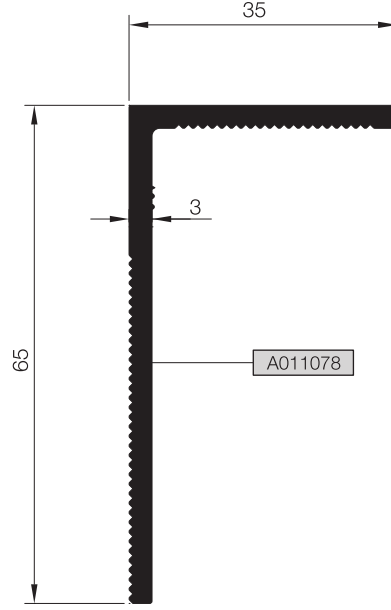

TC22 C 02

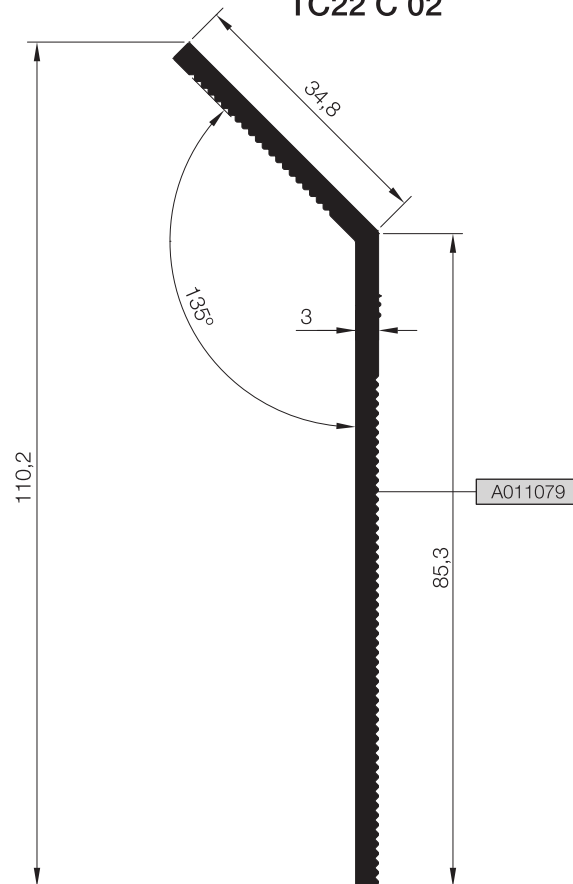

01

02

03

04

05

06

07

08

09

10

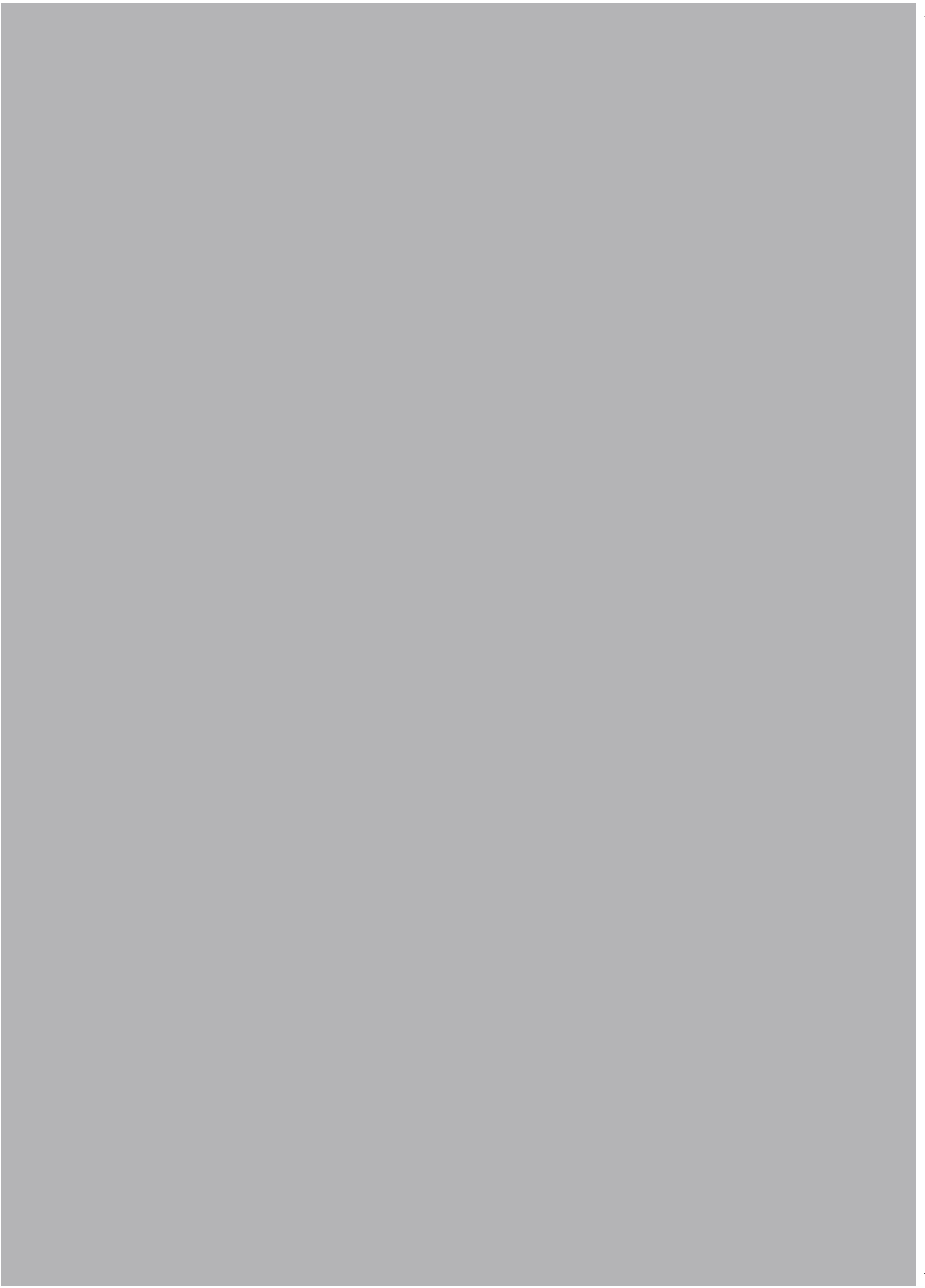

MİMARİ KATALOG ARCHITECTURAL CATALOGUE

Alüminyum Kapı Pencere ve Giydirme Cephe Sistemleri
Aluminium Window Doors and Facade Systems



Rescara Sistem Detayları
Rescara System Details

Rtc22

DETAYLAR

DETAILS

01

02

03

04

05

06

07

08

09

10

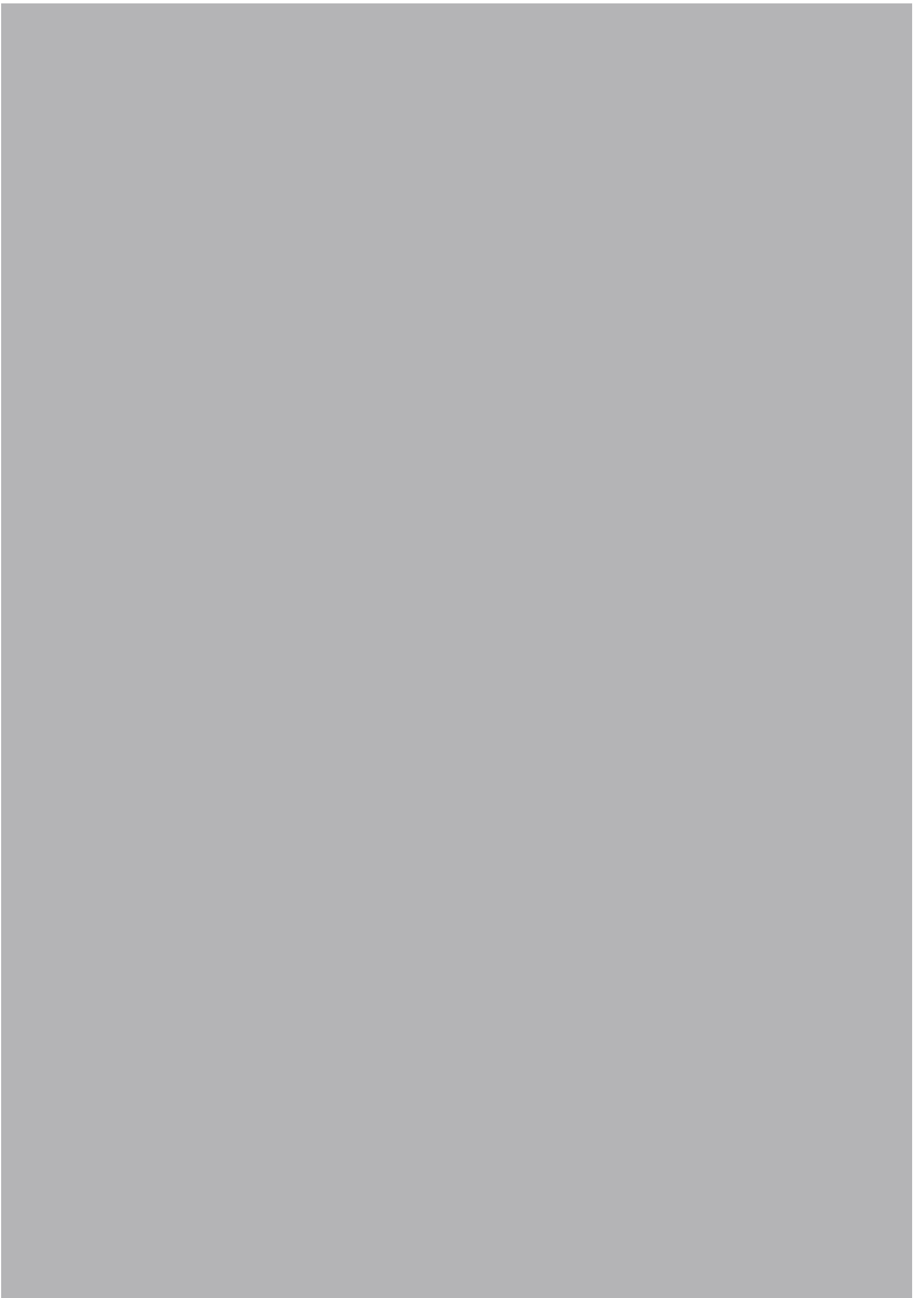

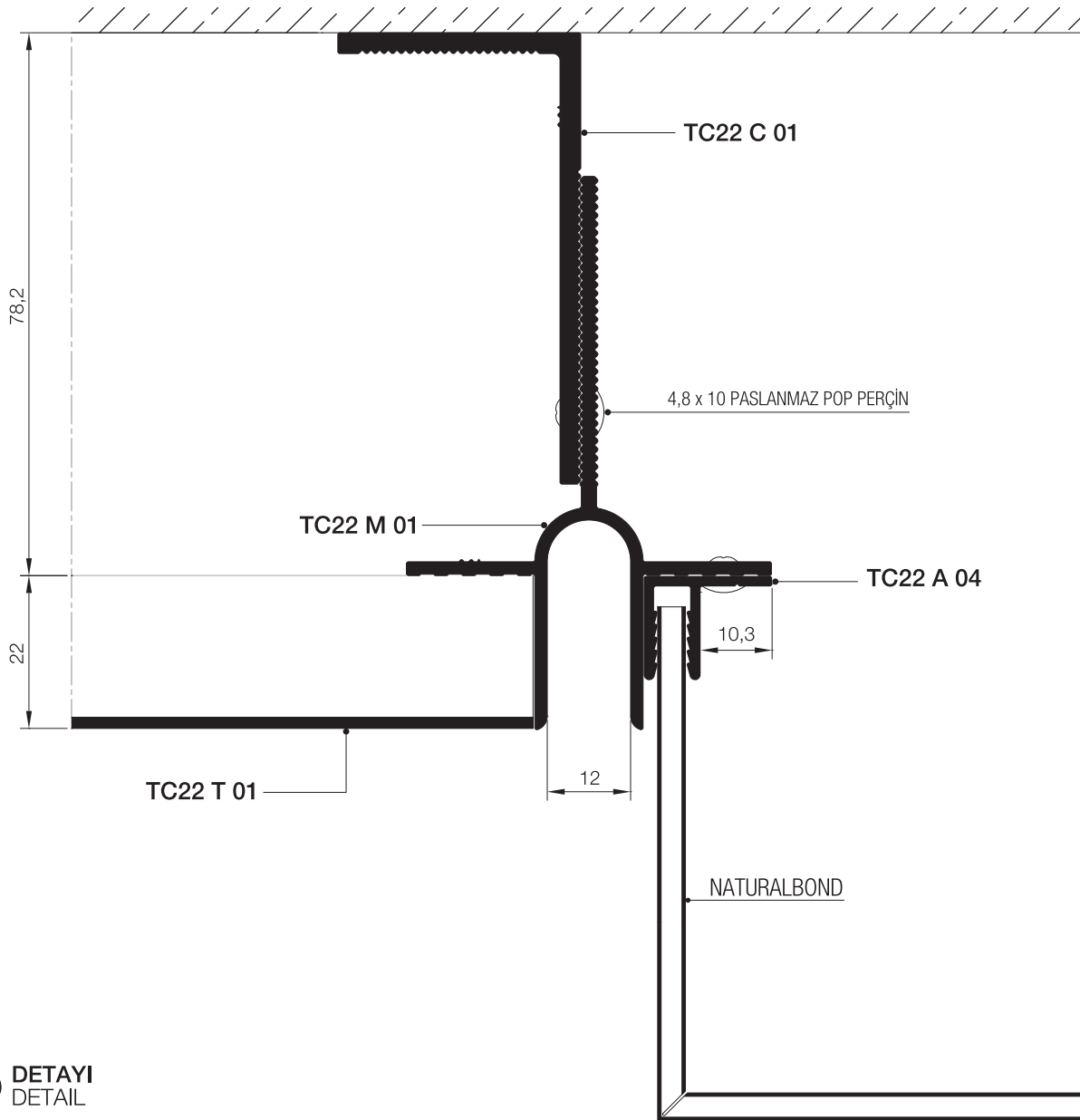
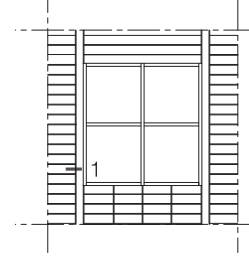

① DETAYI
DETAIL

01

02

03

04

05

06

07

08

09

10

01

02

03

04

05

06

07

08

09

10

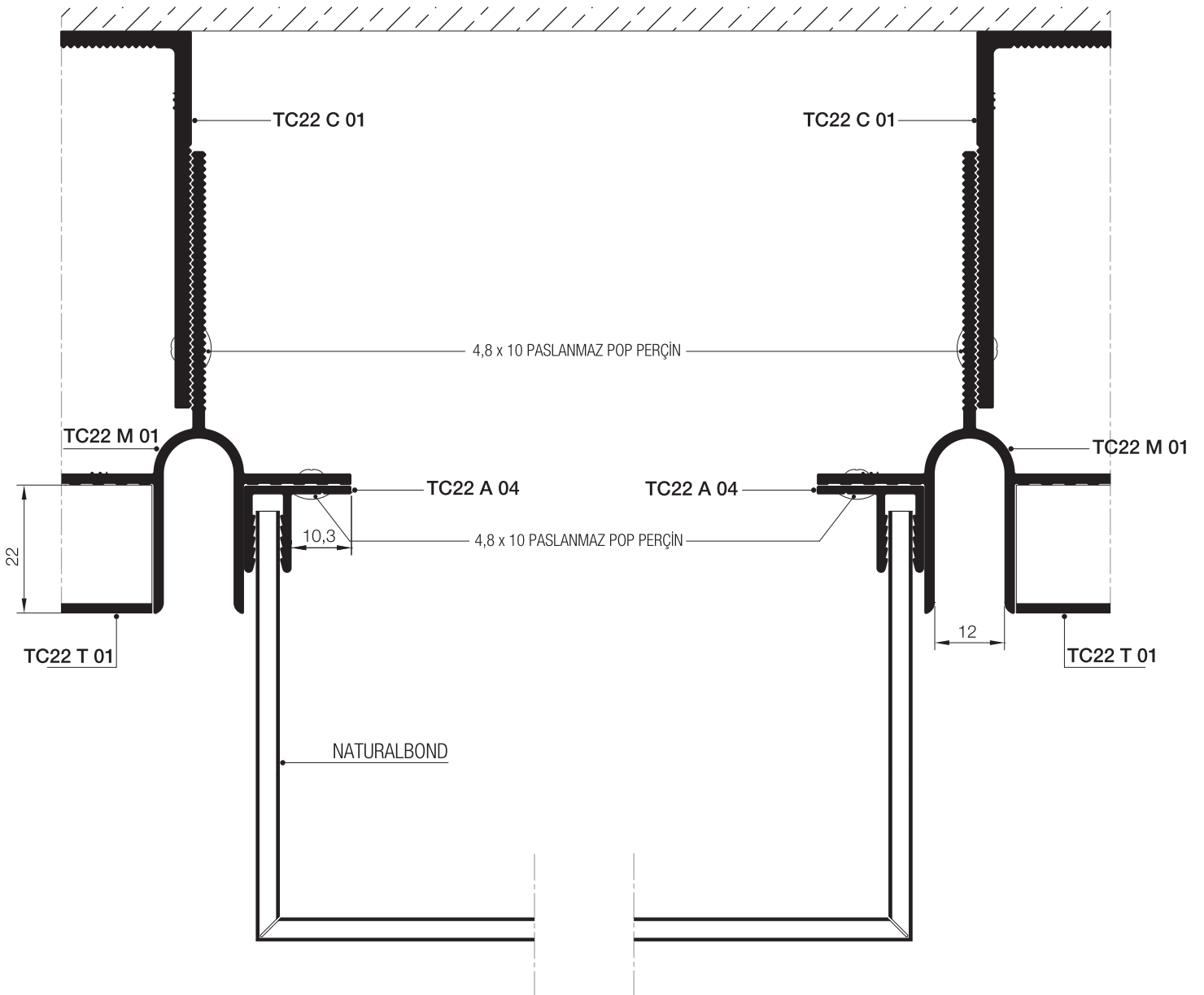
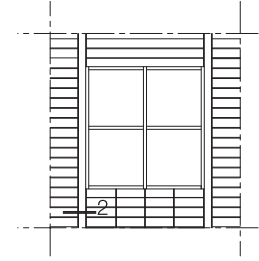

② DETAYI
DETAIL

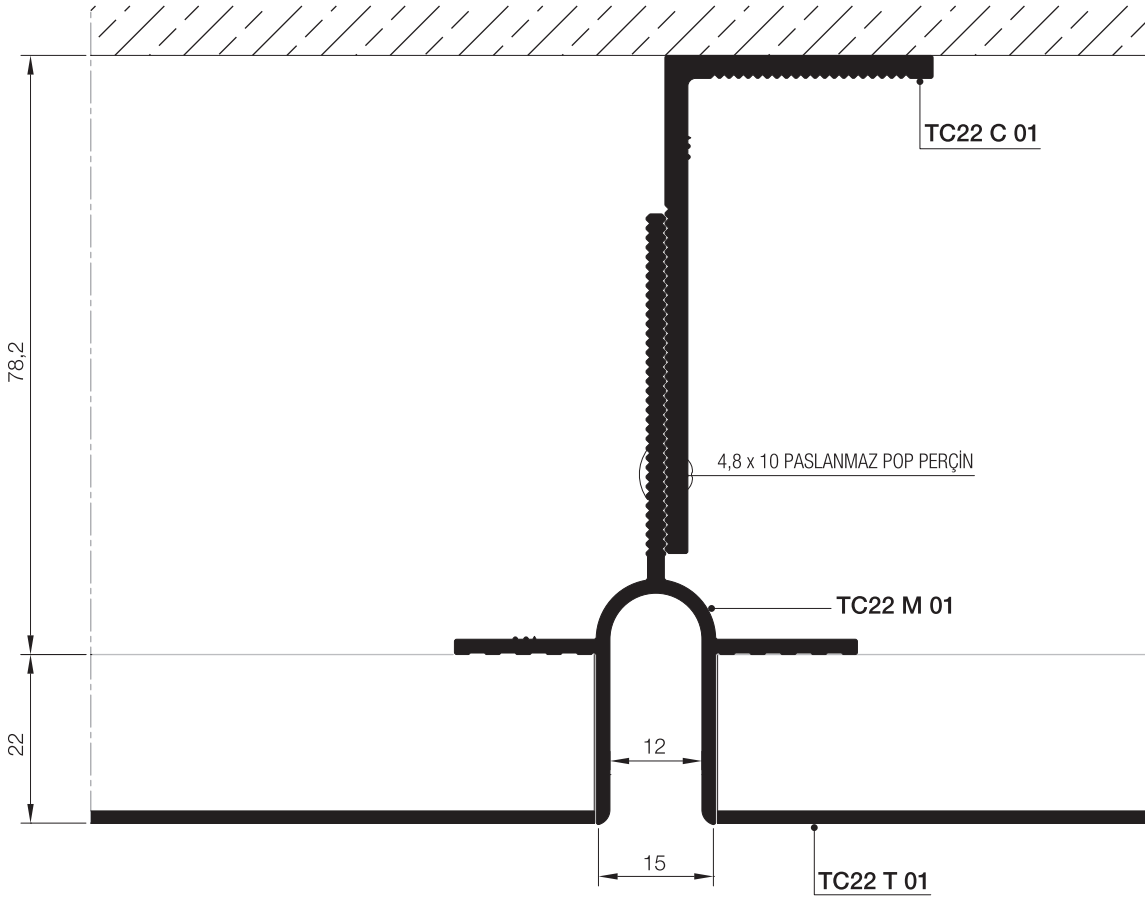
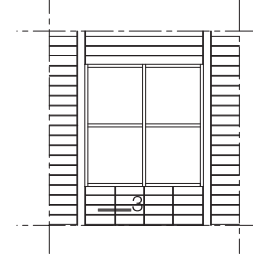

③ DETAYI
DETAIL

01

02

03

04

05

06

07

08

09

10

01

02

03

04

05

06

07

08

09

10

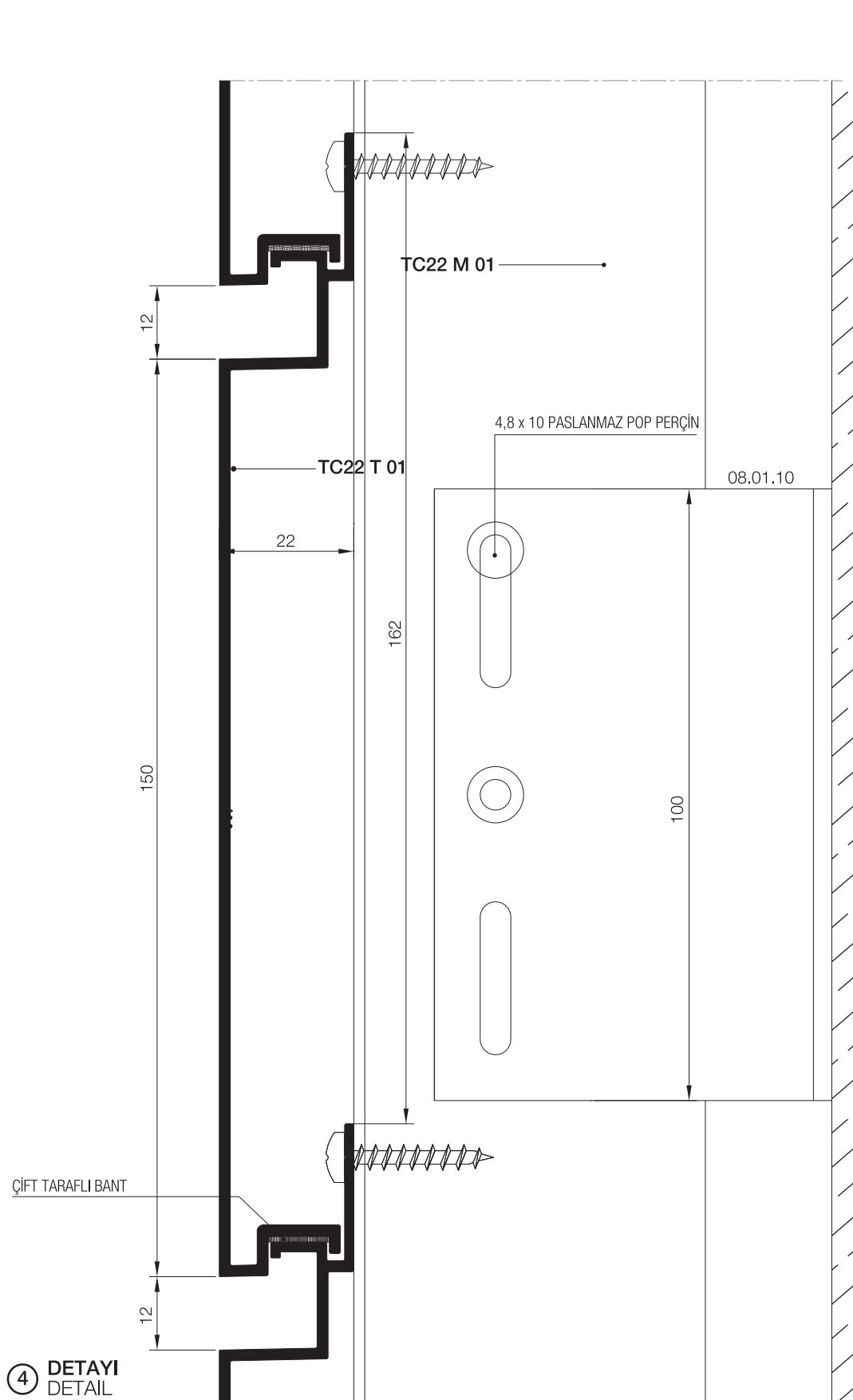

④ DETAYI
DETAIL

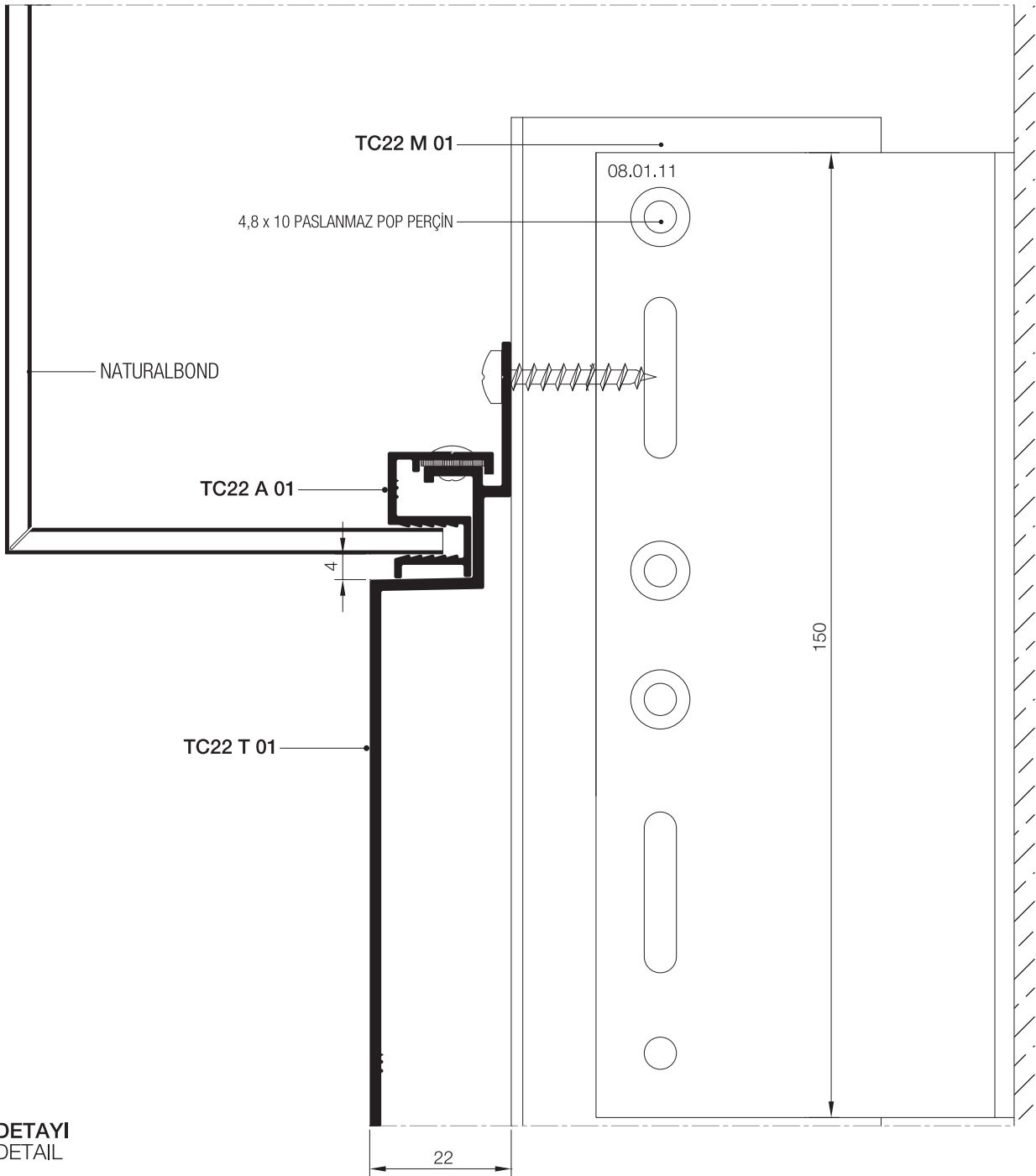
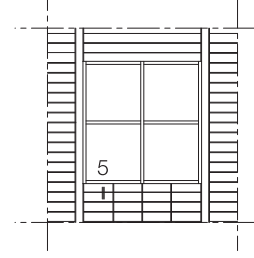

⑤ DETAYI
DETAIL

01

02

03

04

05

06

07

08

09

10

01

02

03

04

05

06

07

08

09

10

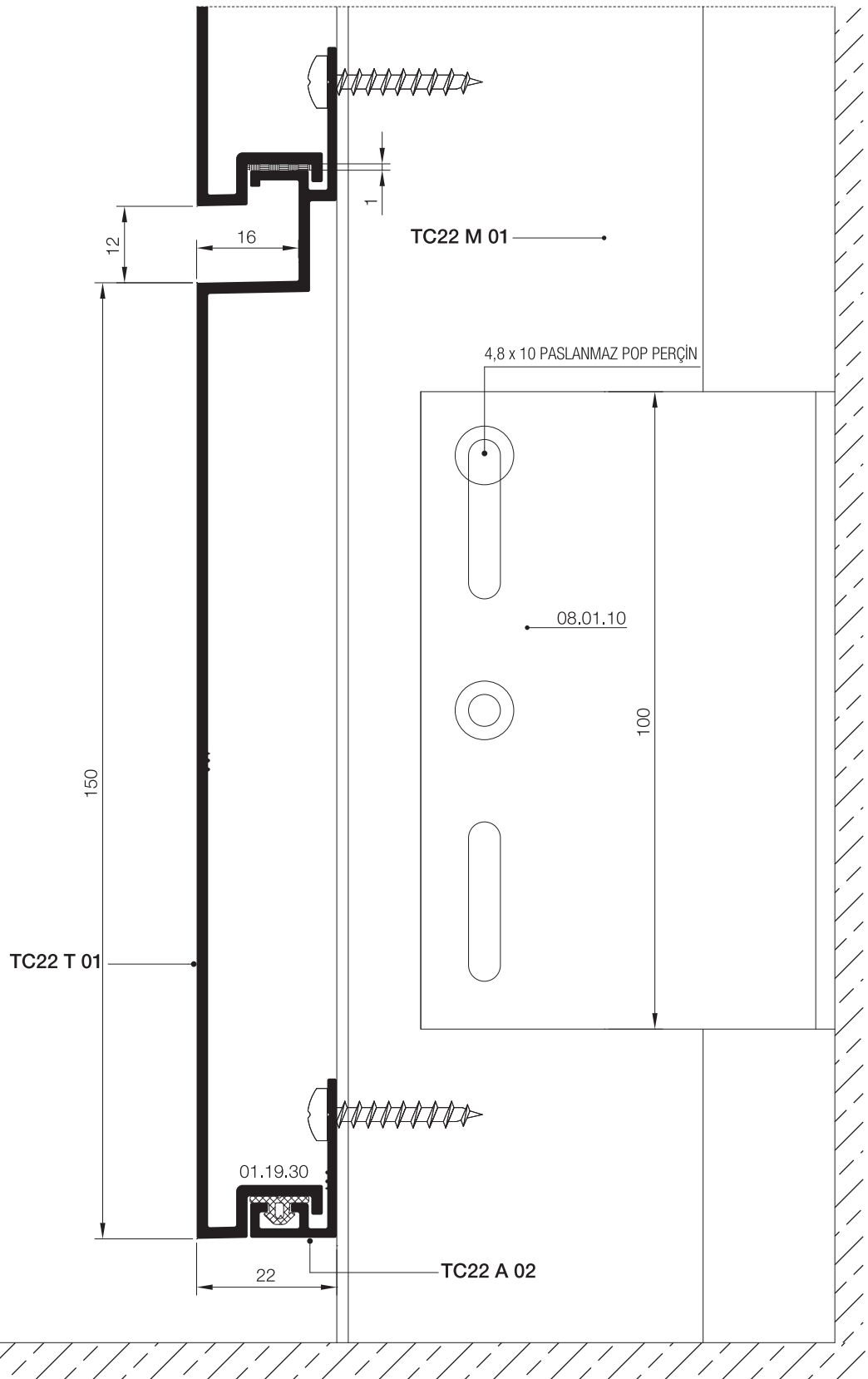
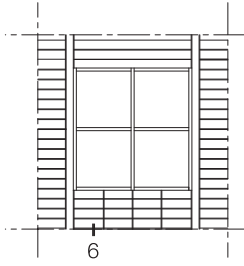

01

02

03

04

05

06

07

08

09

10

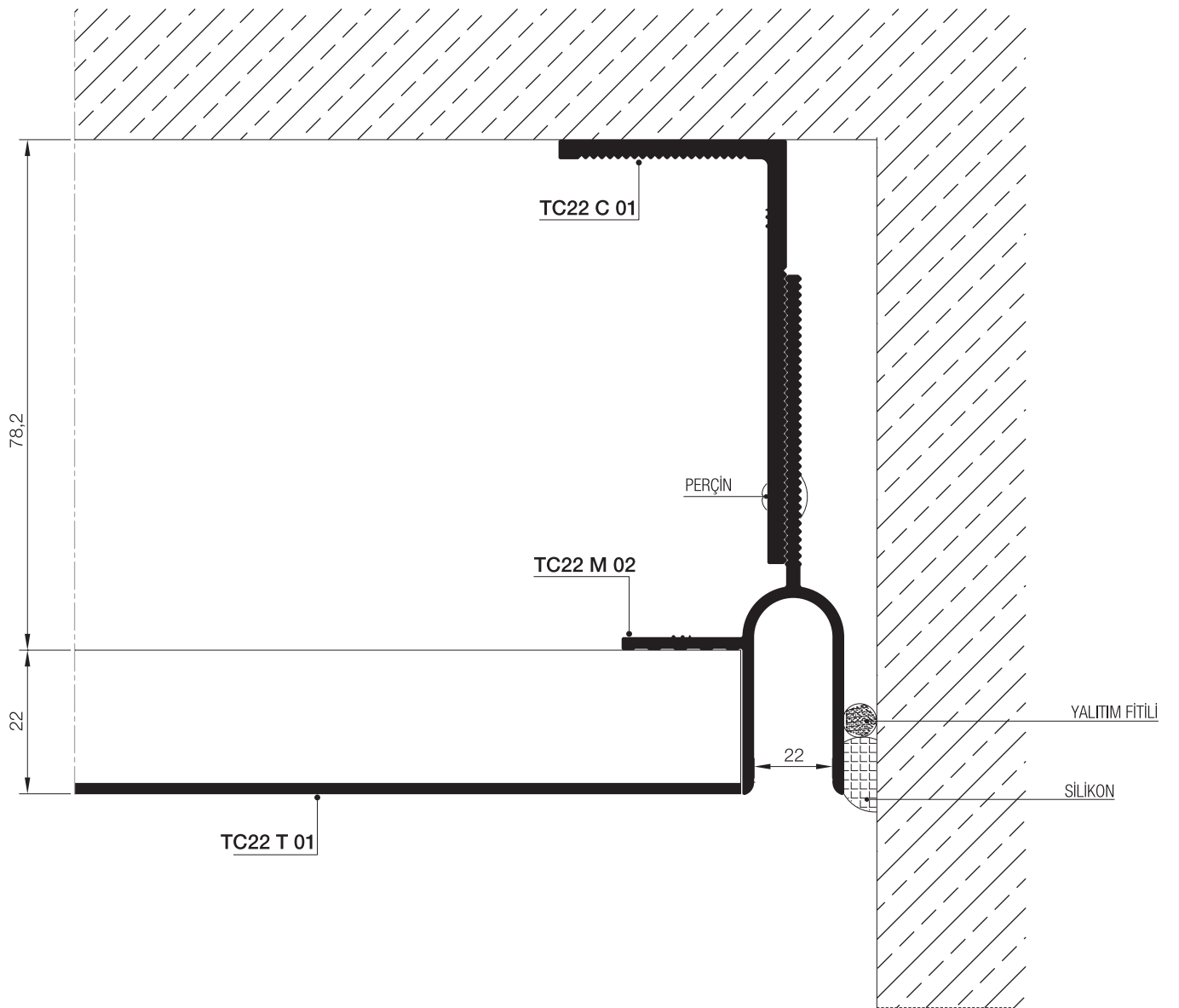
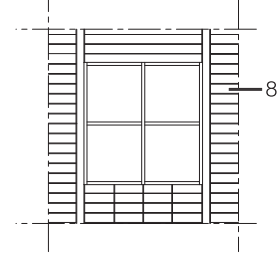

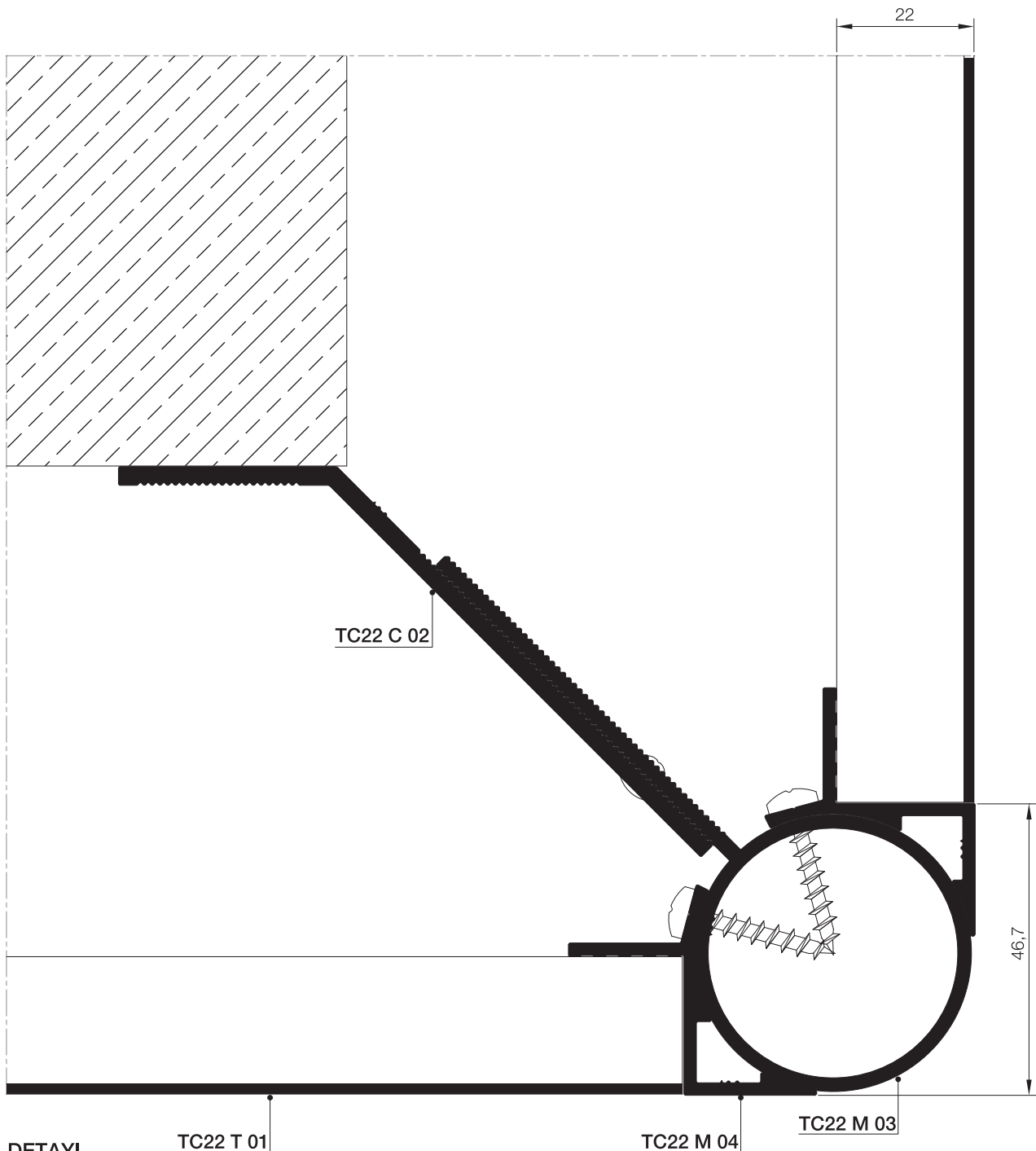
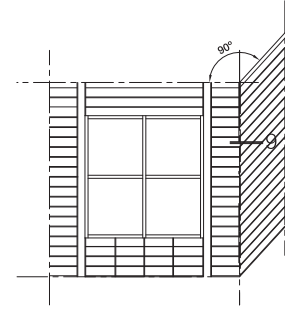

- 01
- 02
- 03
- 04
- 05
- 06
- 07
- 08
- 09
- 10

9 DETAYI
DETAIL

01

02

03

04

05

06

07

08

09

10

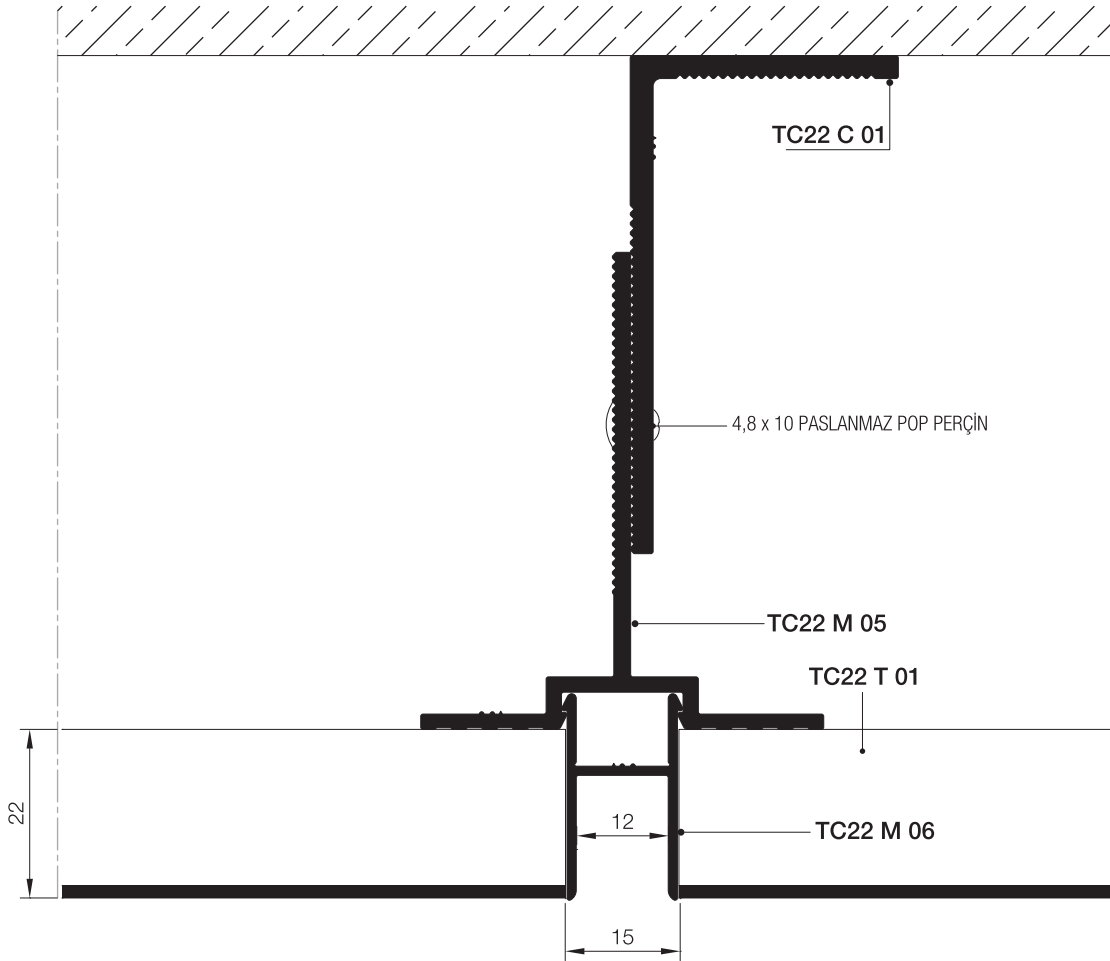
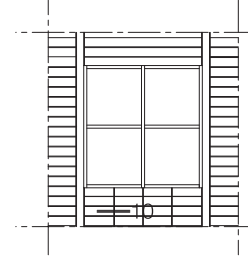

MİMARİ KATALOG ARCHITECTURAL CATALOGUE

Alüminyum Kapı Pencere ve Giydirme Cephe Sistemleri
Aluminium Window Doors and Facade Systems



Rescara Sistem Detayları
Rescara System Details

Rtc22

AKSESUARLAR

ACCESSORIES

01

02

03

04

05

06

07

08

09

10

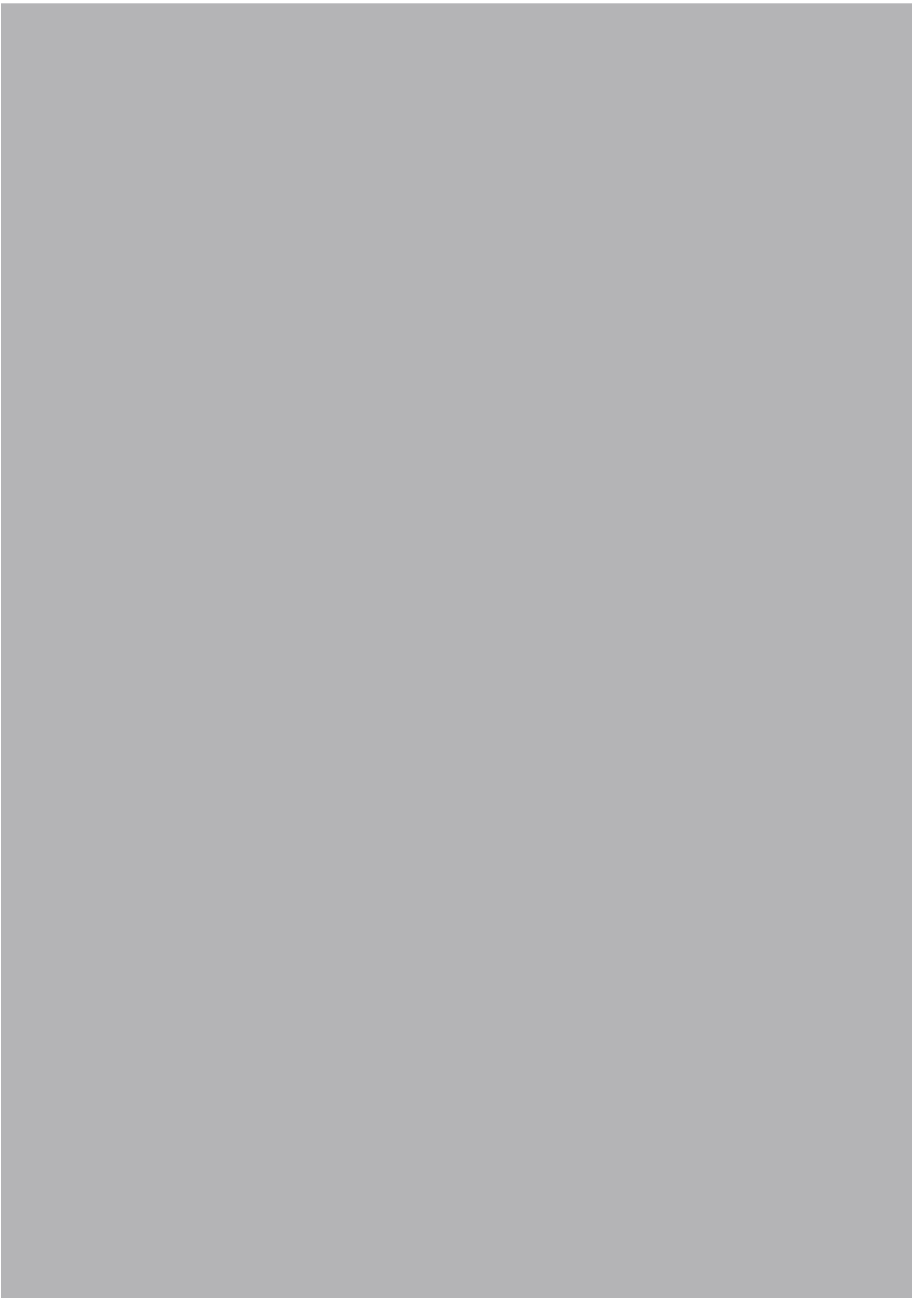

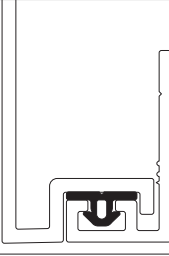
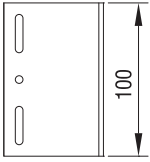
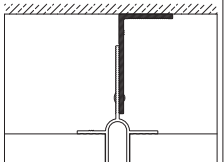
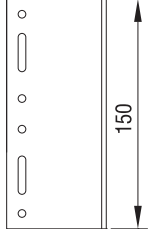
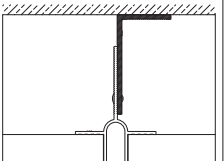
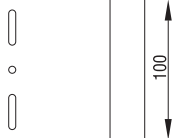
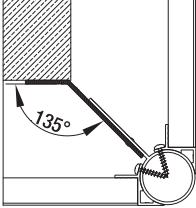
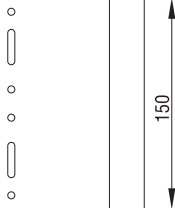
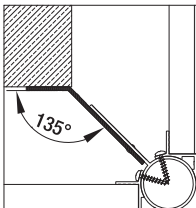
	<p>01.19.30 Bini FİTİLİ GASKET</p> <p>Malzeme / Material : EPDM Ağırlık / Weight : 26 gr/m Paket / Package : 576,9 m / 15 kg</p>				
	<p>08.01.10 100'LÜK ANKRAJ ANCHORAGE (100)</p>				
	<p>08.01.11 150'LİK ANKRAJ ANCHORAGE (150)</p>				
	<p>08.01.12 100'LÜK ANKRAJ ANCHORAGE (100)</p>				
	<p>08.01.13 150'LİK ANKRAJ ANCHORAGE (150)</p>				

01

02

03

04

05

06

07

08

09

10

